

Voltage Regulators with Stand-by Function - Input Voltage: 28V

GENERAL DESCRIPTION

XC6216/XE6216 series are positive voltage regulator ICs with 28V of operation voltage. The series consists of a voltage reference, an error amplifier, a current limiter, a thermal shutdown circuit and a phase compensation circuit plus a driver transistor.

The output voltage is selectable in 0.1V increments within the range of 2.0V to 12V using laser trimming technologies. With external resistors, the output voltage range can be expanded from 2.0V to 23V. The output stabilization capacitor (CL) is also compatible with low ESR ceramic capacitors.

The over current protection circuit and the thermal shutdown circuit are built-in. These two protection circuits will operate when the output current reaches current limit level or the junction temperature reaches temperature limit level.

The CE function enables the output to be turned off and the IC becomes a stand-by mode resulting in greatly reduced power consumption.

APPLICATIONS

- Car audio, Car navigation systems
- Note book computers, PDAs
- Home appliances
- Audio visual equipment
(Cameras, VCRs, etc.)
- Cordless phones,
- Wireless communication equipment

FEATURES

- Max Output Current** : More than 150mA (200mA limit)
($V_{IN}=V_{OUT}+3.0V$)
- Dropout Voltage** : 300mV@ $I_{OUT}=20mA$
- Input Voltage Range** : 2.0V~28.0V
- Output Voltage Setting Range** : 2.0V~12.0V (0.1V increments)
2.0V~23V with external resistors
- High Accuracy** : $\pm 2\%$
 $\pm 1\%$ optional for XC6216 series
- Low Power Consumption** : 5 μA
- Stand-by Current** : Less than 0.1 μA
- High Ripple Rejection** : 30dB@1kHz
- Operating Temperature** : -40 ~+85
- Low ESR Capacitor** : Ceramic Capacitor Compatible
- Current Limit Circuit Built-In**
- Thermal Shutdown Circuit Built-In**
- Small Packages** : SOT-25, SOT-89, SOT-89-5,
USP-6C, SOT-223, TO-252

TYPICAL APPLICATION CIRCUIT

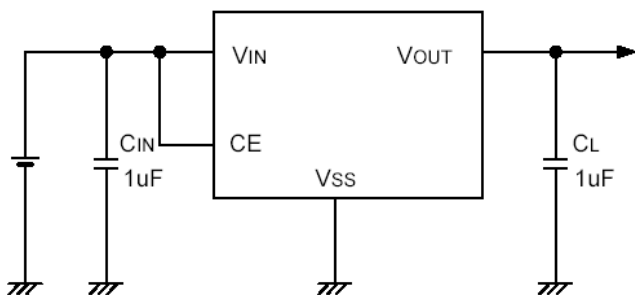

Fixed Output Voltage
XC6216B/XE6216B Series

TYPICAL PERFORMANCE CHARACTERISTICS

Output Voltage vs. Input Voltage

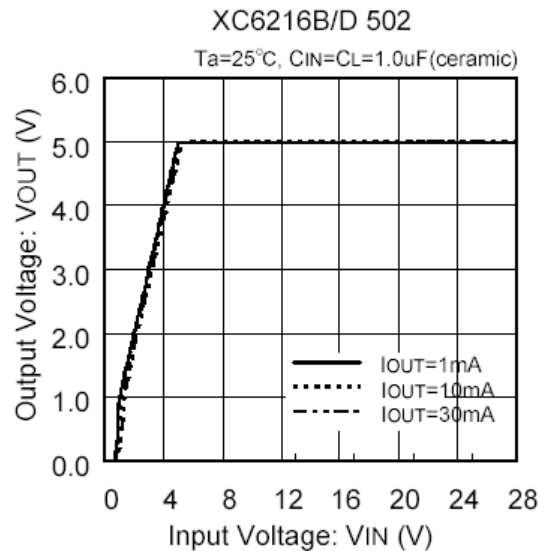

PIN CONFIGURATION

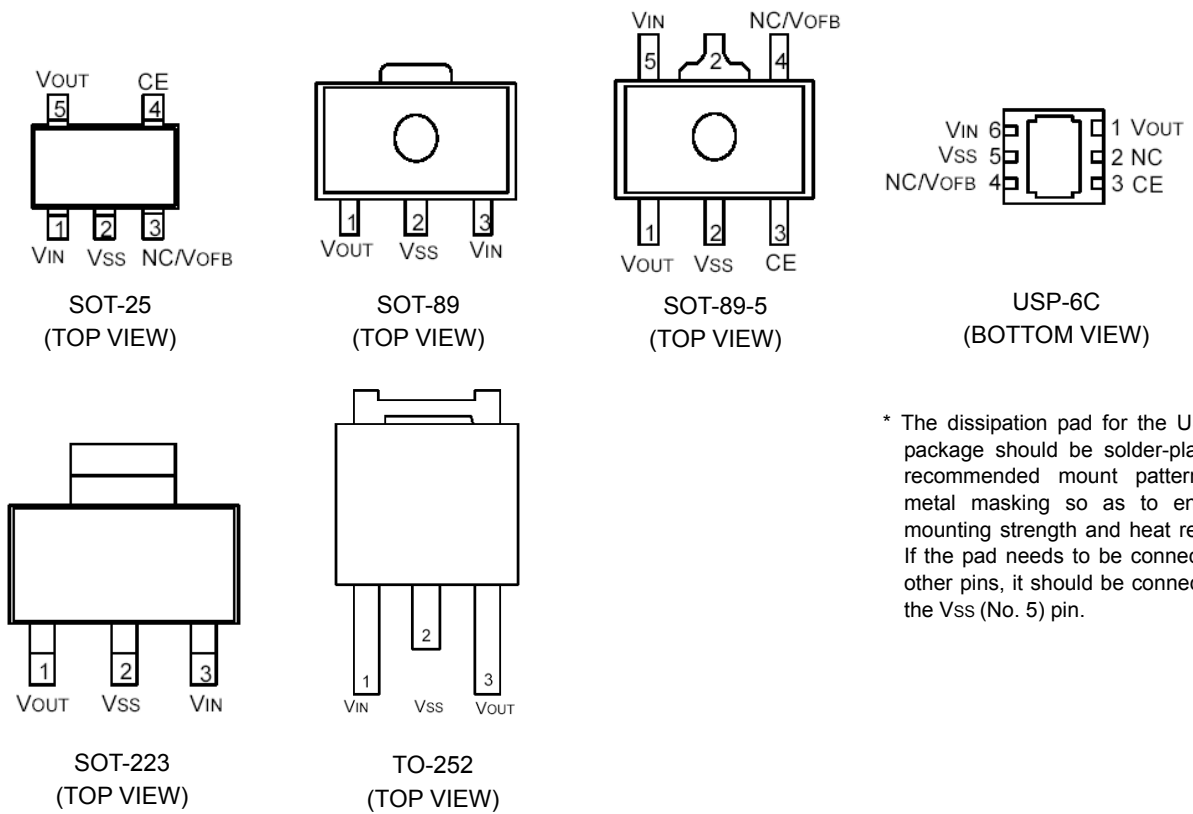

* The dissipation pad for the USP-6C package should be solder-plated in recommended mount pattern and metal masking so as to enhance mounting strength and heat release. If the pad needs to be connected to other pins, it should be connected to the Vss (No. 5) pin.

PIN ASSIGNMENT

XC6216B/XE6216B Series

*The XE6216B in SOT-25 and USP-6C are under development.

PIN NUMBER			PIN NAME	FUNCTIONS
SOT-25*	SOT-89-5	USP-6C*		
1	5	6	VIN	Power Input
2	2	5	Vss	Ground
3	4	4	NC	No connection
4	3	3	CE	ON/OFF Control
5	1	1	VOUT	Output
-	-	2	NC	No connection

XC6216C Series

PIN NUMBER			PIN NAME	FUNCTIONS
SOT-25	SOT-89-5	USP-6C		
1	5	6	VIN	Power Input
2	2	5	Vss	Ground
3	4	4	VOFB	Output Voltage Adjustment
4	3	3	CE	ON/OFF Control
5	1	1	Vout	Output
-	-	2	NC	No connection

XC6216D/XE6216D Series

*The XE6216D in SOT-89, SOT-223 and TO-252 are under development.

PIN NUMBER			PIN NAME	FUNCTIONS
SOT-89*	SOT-223*	TO-252*		
3	3	1	VIN	Power Input
2	2	2	Vss	Ground
1	1	3	Vout	Output

PRODUCT CLASSIFICATION

Ordering Information

XC6216

DESIGNATOR	DESCRIPTION	SYMBOL	DESCRIPTION
	Type and Options of Regulators	B	: Fixed output voltage, High Active
		C	: Output voltage externally set, High Active
		D	: Fixed output voltage, No CE function
	Output Voltage	20 ~ 99	: For the voltage within 2.0V ~9.9V; e.g. 2.5V 25 5.0V 50
		A0 ~ A9 B0 ~ B9 C0	: For the voltage above 10.0V; e.g. 10.6V A6 11.2V B2 12.0V C0
		20	: For C type (output voltage externally set), V _{OFB} =2.0V only
	Output Voltage Accuracy	2	: Within ±2% accuracy
		1*	: Within ±1% accuracy
	Packages	M	: SOT-25 (for B and C types only)
		P	: SOT-89 (for D type only)
			: SOT-89-5 (for B and C types only)
		E	: USP-6C (for B and C types only)
		F	: SOT-223 (for D type only)
J	: TO-252 (for D type only)		
	Device Orientation	R	: Embossed tape, standard feed
		L	: Embossed tape, reverse feed

* 1% Output Voltage Accuracy is not available in XC6216C.

XE6216

DESIGNATOR	DESCRIPTION	SYMBOL	DESCRIPTION
	Type and Options of Regulators	B	: Fixed output voltage, High Active
		D	: Fixed output voltage, without CE function
	Output Voltage	20 ~ 99	: For the voltage within 2.0V ~9.9V; e.g. 2.5V 25 5.0V 50
		A0 ~ A9 B0 ~ B9 C0	: For the voltage above 10.0V; e.g. 10.6V A6 11.2V B2 12.0V C0
		20	: For C type (output voltage externally set), V _{OFB} =2.0V only
	Output Voltage Accuracy	2	: Within ±2% accuracy
	Package	M	: SOT-25 (for B type only) *
		P	: SOT-89 (for D type only) *
			: SOT-89-5 (for B type only)
E	: USP-6C (for B type only) *		
	Device Orientation	R	: Embossed tape, standard feed
		L	: Embossed tape, reverse feed

*The XE6216Bxx2M, XE6216Dxx2P, XC6216Bxx2E are under development.

XC6216/XE6216 Series

BLOCK DIAGRAMS

XC6216B/XE6216B Series
(SOT-25, SOT-89-5, USP-6C)

*XE6216B in SOT-25 and USP-6C are under development.

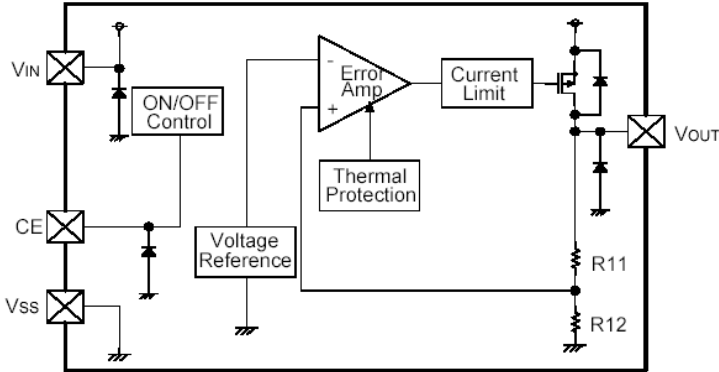

XC6216C Series
(SOT-25, SOT-89-5, USP-6C)

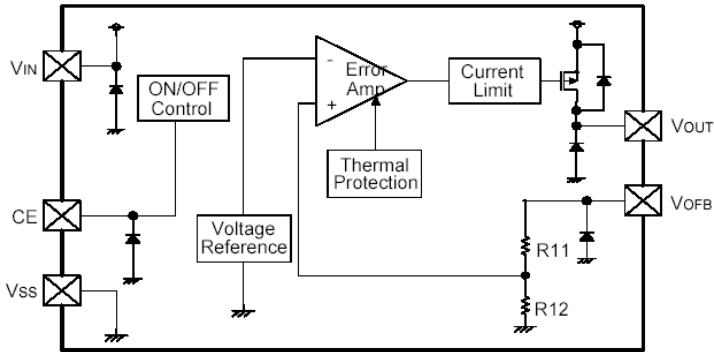

XC6216D/XE6216D Series
(SOT-89, SOT-223, TO-252)

*The XE6216D in SOT-89, SOT-223 and TO-252 are under development.

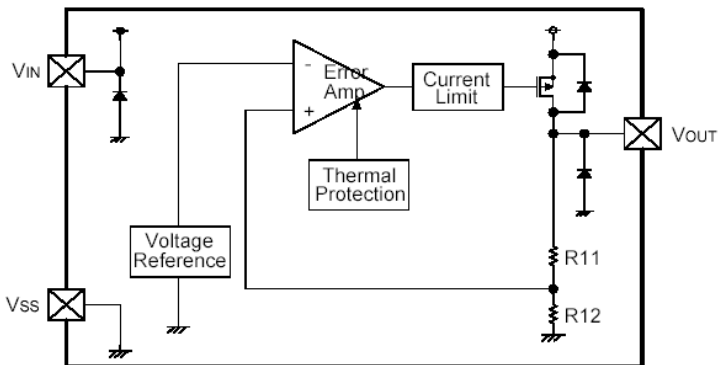

ABSOLUTE MAXIMUM RATINGS

XC6216B Series

PARAMETER		SYMBOL	RATINGS	UNITS
Input Voltage		V _{IN}	V _{SS} -0.3~30	V
Output Current		I _{OUT}	300 ^{(*)1}	mA
Output Voltage		V _{OUT}	V _{SS} -0.3~V _{IN} +0.3	V
CE Input Voltage		V _{CE}	V _{SS} -0.3~30	V
Power Dissipation	SOT-25	P _d	250	mW (T _J =25)
			600 (PCB mounted) ^{(*)2}	
	SOT-89-5		500	
			1300 (PCB mounted) ^{(*)2}	
	USP-6C		100	
		1000 (PCB mounted) ^{(*)2}		
Operating Temperature Range		T _{opr}	-40~+85	
Storage Temperature Range		T _{stg}	-55~+125	

*1: I_{OUT} P_d / (V_{IN}-V_{OUT})

*2: The power dissipation figure shown is PCB mounted. Please refer to pages 37 ~ 40 for details.

XC6216C Series

PARAMETER		SYMBOL	RATINGS	UNITS
Input Voltage		V _{IN}	V _{SS} -0.3~30	V
Output Current		I _{OUT}	300 ^{(*)1}	mA
Output Voltage		V _{OUT}	V _{SS} -0.3~V _{IN} +0.3	V
CE Input Voltage		V _{CE}	V _{SS} -0.3 ~ 30	V
FB Voltage		V _{OFB}	V _{SS} -0.3 ~ 30	V
Power Dissipation	SOT-25	P _d	250	mW (T _J =25)
			600 (PCB mounted) ^{(*)2}	
	SOT-89-5		500	
			1300 (PCB mounted) ^{(*)2}	
	USP-6C		100	
		1000 (PCB mounted) ^{(*)2}		
Operating Temperature Range		T _{opr}	-40~+85	
Storage Temperature Range		T _{stg}	-55~+125	

*1: I_{OUT} P_d / (V_{IN}-V_{OUT})

*2: The power dissipation figure shown is PCB mounted. Please refer to pages 37 ~ 40 for details.

XC6216D Series

PARAMETER		SYMBOL	RATINGS	UNITS
Input Voltage		V _{IN}	V _{SS} -0.3~30	V
Output Current		I _{OUT}	300 ^{(*)1}	mA
Output Voltage		V _{OUT}	V _{SS} -0.3~V _{IN} +0.3	V
Power Dissipation	SOT-89	P _d	500	mW (T _J =25)
	SOT-223		300	
			1500 (PCB mounted) ^{(*)2}	
TO-252		500		
Operating Temperature Range		T _{opr}	-40~+85	
Storage Temperature Range		T _{stg}	-55~+125	

*1: I_{OUT} P_d / (V_{IN}-V_{OUT})

*2: The power dissipation figure shown is PCB mounted. Please refer to pages 37 ~ 40 for details.

ABSOLUTE MAXIMUM RATINGS (Continued)

XE6216B Series

*The XE6216B in SOT-25 and USP-6C are under development.

PARAMETER		SYMBOL	RATINGS	UNITS
Input Voltage		V_{IN}	$V_{SS}-0.3 \sim 30$	V
Output Current		I_{OUT}	300 ^(*)	mA
Output Voltage		V_{OUT}	$V_{SS}-0.3 \sim V_{IN}+0.3$	V
CE Input Voltage		V_{CE}	$V_{SS}-0.3 \sim 30$	V
Power Dissipation	SOT-25	Pd	250	mW ($T_J=25$)
			600 (PCB mounted) ^(**)	
	SOT-89-5		500	
			1300 (PCB mounted) ^(**)	
	USP-6C		100	
		1000 (PCB mounted) ^(**)		
Operating Temperature Range		Topr	-40 ~ +85	
Junction Temperature		T_J	-40 ~ +125	
Storage Temperature Range		Tstg	-55 ~ +125	

*1: $I_{OUT} \cdot Pd / (V_{IN}-V_{OUT})$

*2: The power dissipation figure shown is PCB mounted. Please refer to pages 37 ~ 40 for details.

XE6216D Series

*Under Development

PARAMETER		SYMBOL	RATINGS	UNITS
Input Voltage		V_{IN}	$V_{SS}-0.3 \sim 30$	V
Output Current		I_{OUT}	300 ^(*)	mA
Output Voltage		V_{OUT}	$V_{SS}-0.3 \sim V_{IN}+0.3$	V
CE Input Voltage		V_{CE}	$V_{SS}-0.3 \sim 30$	V
Power Dissipation	SOT-89	Pd	500	mW ($T_J=25$)
Operating Temperature Range		Topr	-40 ~ +85	
Junction Temperature		T_J	-40 ~ +125	
Storage Temperature Range		Tstg	-55 ~ +125	

*1: $I_{OUT} \cdot Pd / (V_{IN}-V_{OUT})$

ELECTRICAL CHARACTERISTICS

XC6216B Series

Ta = 25

PARAMETER	SYMBOL	CONDITIONS	MIN.	TYP.	MAX.	UNITS	CIRCUIT
Output Voltage	V _{OUT(E)}	I _{OUT} =20mA, V _{CE} =V _{IN}	E-0			V	
Maximum Output Current	I _{OUTMAX}	V _{IN} =V _{OUT(T)} +3.0V, V _{CE} =V _{IN} (V _{OUT(T)} ≥ 3.0V)	150	-	-	mA	
		V _{IN} =V _{OUT(T)} +3.0V, V _{CE} =V _{IN} (V _{OUT(T)} < 3.0V)	100	-	-	mA	
Load Regulation	V _{OUT}	V _{IN} =V _{OUT(T)} +2.0V, 1mA I _{OUT} 50mA, V _{CE} =V _{IN} , (2.0V ≤ V _{OUT(T)} ≤ 7.0V)	-	50	90	mV	
		V _{IN} =V _{OUT(T)} +2.0V, 1mA I _{OUT} 50mA, V _{CE} =V _{IN} , (7.1V ≤ V _{OUT(T)} ≤ 12.0V)	-	110	140	mV	
Dropout Voltage 1	V _{dif1}	I _{OUT} =20mA, V _{CE} =V _{IN}	E-1			mV	
Dropout Voltage 2	V _{dif2}	I _{OUT} =100mA, V _{IN} = V _{OUT(T)} +3.0V, V _{CE} =V _{IN} (V _{OUT(T)} <3.0V)	E-2			mV	
		I _{OUT} =100mA, V _{CE} =V _{IN} (V _{OUT(T)} <3.0V)					
Supply Current	I _{SS}	V _{CE} =V _{IN}	1	5	9	μA	
Stand-by Current	I _{stby}	V _{CE} =V _{SS}	-	0.01	0.10	μA	
Line Regulation 1	V _{OUT} / V _{IN} · V _{OUT(T)}	V _{OUT(T)} +2.0V V _{IN} 28.0V I _{OUT} =5mA, V _{CE} =V _{IN}	0.01	0.05	0.10	%/V	
Line Regulation 2	V _{OUT} / V _{IN} · V _{OUT(T)}	V _{OUT(T)} +2.0V V _{IN} 28.0V I _{OUT} =13mA, V _{CE} =V _{IN}	0.03	0.15	0.30	%/V	
Input Voltage	V _{IN}		2.0	-	28.0	V	-
Output Voltage Temperature Characteristics	V _{OUT} / Ta · V _{OUT(T)}	I _{OUT} =20mA, V _{CE} =V _{IN} -40 ≤ Ta ≤ 85	-	± 100	-	ppm/	
Ripple Rejection Rate	PSRR	V _{IN} =[V _{OUT(T)} +2.0]V+0.5V _{p-pAC} I _{OUT} =20mA, f=1kHz, V _{CE} =V _{IN}	-	30	-	dB	
Short Current	I _{short}	V _{IN} =V _{OUT(T)} +2.0V, V _{CE} =V _{IN}	-	30	-	mA	
CE "H" Level Voltage	V _{CEH}	V _{IN} =28.0V	1.1	-	28.0	V	
CE "L" Level Voltage	V _{CEL}	V _{IN} =28.0V	0	-	0.35	V	
CE "H" Level Current	I _{CEH}	V _{IN} =V _{CE} =28.0V	-0.1	-	0.1	μA	
CE "L" Level Current	I _{CEL}	V _{IN} =28.0V, V _{CE} =V _{SS}	-0.1	-	0.1	μA	

Thermal Shutdown Detect Temperature	T _{TSD}	Junction Temperature	-	150	-		
Thermal Shutdown Release Temperature	T _{TSR}	Junction Temperature	-	125	-		
Hysteresis Width	T _{TSD} -T _{TSR}	Junction Temperature	-	25	-		-

NOTE:

*1: V_{OUT(T)}: Specified output voltage

*2: V_{OUT(E)}: Effective output voltage

(i.e. the output voltage when "V_{OUT(T)}+2.0V" is provided at the V_{IN} pin while maintaining a certain I_{OUT} value.)

*3: V_{dif}={V_{IN1}^(Note 5) - V_{OUT1}^(Note 4)}

*4: V_{OUT1}: V_{OUT(T)} < 3.0V, A voltage equal to 98% of the output voltage whenever an amply stabilized I_{OUT}{V_{OUT(T)}+3.0V} is input.

V_{OUT(T)} ≥ 3.0V, A voltage equal to 98% of the output voltage whenever an amply stabilized I_{OUT}{V_{OUT(T)}+2.0V} is input.

*5: V_{IN1}: The input voltage when V_{OUT1} appears as input voltage is gradually decreased.

*6: Unless otherwise stated, V_{IN}=V_{OUT(T)}+2.0V.

ELECTRICAL CHARACTERISTICS (Continued)

XC6216C Series

Ta = 25

PARAMETER	SYMBOL	CONDITIONS	MIN.	TYP.	MAX.	UNITS	CIRCUIT
Output Voltage	V _{OUT(E)}	I _{OUT} =20mA, V _{CE} =V _{IN} , V _{OFB} =V _{OUT}	1.96	2.00	2.04	V	
Divided Resistor	RFB	V _{IN} =V _{OUT} =5.0V, V _{CE} =V _{SS} V _{OFB} =V _{OUT}	1.70	4.10	6.30	M	
Maximum Output Current	I _{OUTMAX}	V _{IN} =5.0V, V _{CE} =V _{IN} , V _{OFB} =V _{OUT}	100	-	-	mA	
Load Regulation	V _{OUT}	V _{IN} =4.0V 1mA I _{OUT} 50mA, V _{CE} =V _{IN} , V _{OFB} =V _{OUT}	-	50	90	mV	
Dropout Voltage1	V _{dif1}	I _{OUT} =20mA, V _{CE} =V _{IN} , V _{OFB} =V _{OUT}	-	450	600	mV	
Dropout Voltage2	V _{dif2}	I _{OUT} =100mA, V _{IN} =5.0V, V _{CE} =V _{IN} , V _{OFB} =V _{OUT}	-	1900	2600-	mV	
Supply Current	I _{SS}	V _{CE} =V _{IN} , V _{OFB} =V _{OUT}	1	5	9	μA	
Stand-by Current	I _{stby}	V _{CE} =V _{SS} , V _{OFB} =V _{OUT}	-	0.01	0.10	μA	
Line Regulation1	V _{OUT} / V _{IN} · V _{OUT(T)}	4.0V V _{IN} 28.0V, I _{OUT} =5mA, V _{CE} =V _{IN} , V _{OFB} =V _{OUT}	-	0.05	0.10	%/V	
Line Regulation2	V _{OUT} / V _{IN} · V _{OUT(T)}	4.0V V _{IN} 28.0V, I _{OUT} =13mA, V _{CE} =V _{IN} , V _{OFB} =V _{OUT}	-	0.15	0.30	%/V	
Input Voltage	V _{IN}		2.0	-	28.0	V	-
Output Voltage Temperature Characteristics	V _{OUT} / Ta · V _{OUT(T)}	I _{OUT} =20mA, V _{CE} =V _{IN} , -40 Ta 85	-	± 100	-	ppm/	
Ripple Rejection Rate	PSRR	V _{IN} =4.0V+0.5V _{p-pAC} , I _{OUT} =20mA, f=1kHz, V _{CE} =V _{IN} V _{OFB} =V _{OUT}	-	30	-	dB	
Short Current	I _{short}	V _{IN} =4.0V, V _{CE} =V _{IN} , V _{OFB} =V _{OUT}	-	30	-	mA	
CE "H" Level Voltage	V _{CEH}	V _{IN} =28.0V, V _{OFB} =V _{OUT}	1.1	-	28.0	V	
CE "L" Level Voltage	V _{CEL}	V _{IN} =28.0V, V _{OFB} =V _{OUT}	0	-	0.5	V	
CE "H" Level Current	I _{CEH}	V _{IN} =V _{CE} =28.0V, V _{OFB} =V _{OUT}	-0.1	-	0.1	μA	
CE "L" Level Current	I _{CEL}	V _{IN} =28.0V, V _{CE} =V _{SS} V _{OFB} =V _{OUT}	-0.1	-	0.1	μA	

Thermal Shutdown Detect Temperature	T _{TSD}	Junction Temperature	-	150	-		
Thermal Shutdown Release Temperature	T _{TSR}	Junction Temperature	-	125	-		
Hysteresis Width	T _{TSD} -T _{TSR}	Junction Temperature	-	25	-		-

NOTE:

*1: V_{OUT(T)}: Specified output voltage

*2: V_{OUT(E)}: Effective output voltage

(i.e. the output voltage when "V_{OUT(T)}+2.0V" is provided at the V_{IN} pin while maintaining a certain I_{OUT} value.)

*3: V_{dif}={V_{IN1}^{Note 5} - V_{OUT1}^{Note 4}}

*4: V_{OUT1}: A voltage equal to 98% of the output voltage whenever an amply stabilized I_{OUT}{V_{OUT(T)}+3.0V} is input.

*5: V_{IN1}: The input voltage when V_{OUT1} appears as input voltage is gradually decreased.

*6: Unless otherwise stated, V_{IN}=V_{OUT(T)}+2.0V.

ELECTRICAL CHARACTERISTICS (Continued)

XC6216D Series

Ta = 25

PARAMETER	SYMBOL	CONDITIONS	MIN.	TYP.	MAX.	UNITS	CIRCUIT
Output Voltage	V _{OUT(E)}	I _{OUT} =20mA	E-0			V	
Maximum Output Current	I _{OUTMAX}	V _{IN} =V _{OUT(T)} +3.0V, (V _{OUT(T)} 3.0V)	150	-	-	mA	
		V _{IN} =V _{OUT(T)} +3.0V, (V _{OUT(T)} < 3.0V)	100	-	-	mA	
Load Regulation	V _{OUT}	V _{IN} =V _{OUT(T)} +2.0V 1mA I _{OUT} 50mA (2.0V V _{OUT(T)} 7.0V)	-	50	90	mV	
		V _{IN} =V _{OUT(T)} +2.0V 1mA I _{OUT} 50mA (7.1 V _{OUT(T)} 12.0V)	-	110	140	mV	
Dropout Voltage1	V _{dif1}	I _{OUT} =20mA	E-1			mV	
Dropout Voltage2	V _{dif2}	I _{OUT} =100mA, V _{IN} =V _{OUT(T)} +3.0V (V _{OUT(T)} < 3.0V)	E-2			mV	
		I _{OUT} =100mA, (V _{OUT(T)} 3.0V)					
Supply Current	I _{SS}		1	5	9	μA	
Line Regulation1	V _{OUT} / V _{IN} · V _{OUT(T)}	V _{OUT(T)} +2.0V V _{IN} 28.0V I _{OUT} =5mA	-	0.05	0.10	%/V	
Line Regulation2	V _{OUT} / V _{IN} · V _{OUT(T)}	V _{OUT(T)} +2.0V V _{IN} 28.0V I _{OUT} =13mA	-	0.15	0.30	%/V	
Input Voltage	V _{IN}		2.0	-	28.0	V	-
Output Voltage Temperature Characteristics	V _{OUT} / Ta · V _{OUT(T)}	I _{OUT} =20mA, V _{CE} =V _{IN} -40 Ta 85	-	± 100	-	ppm/	
Ripple Rejection Rate	PSRR	V _{IN} =[V _{OUT(T)} +2.0]V+0.5V _{p-pAC} I _{OUT} =20mA, f=1kHz	-	30	-	dB	
Short Current	I _{short}	V _{IN} =V _{OUT(T)} +2.0V	-	30	-	mA	
Thermal Shutdown Detect Temperature	T _{TSD}	Junction Temperature	-	150	-		-
Thermal Shutdown Release Temperature	T _{TSR}	Junction Temperature	-	125	-		-
Hysteresis Width	T _{TSD} -T _{TSR}	Junction Temperature	-	25	-		-

NOTE:

*1: V_{OUT(T)}: Specified output voltage

*2: V_{OUT(E)}: Effective output voltage

(i.e. the output voltage when "V_{OUT(T)}+2.0V" is provided at the V_{IN} pin while maintaining a certain I_{OUT} value.)

*3: V_{dif}={V_{IN1}^(Note 5) - V_{OUT1}^(Note 4)}

*4: V_{OUT1}: V_{OUT(T)} < 3.0V, A voltage equal to 98% of the output voltage whenever an amply stabilized I_{OUT}{V_{OUT(T)}+3.0V} is input.
V_{OUT(T)} 3.0V, A voltage equal to 98% of the output voltage whenever an amply stabilized I_{OUT}{V_{OUT(T)}+2.0V} is input.

*5: V_{IN1}: The input voltage when V_{OUT1} appears as input voltage is gradually decreased.

*6: Unless otherwise stated, V_{IN}=V_{OUT(T)}+2.0V.

ELECTRICAL CHARACTERISTICS (Continued)

● Voltage Chart

PARAMETER	E-0				E-1		E-2	
	OUTPUT VOLTAGE (V) 2% ACCURACY		OUTPUT VOLTAGE (V) 1% ACCURACY		DROPOUT VOLTAGE 1 (mV) $I_{OUT}=20mA$		DROPOUT VOLTAGE 2 (mV) $I_{OUT}=100mA$	
	V_{OUT}		V_{OUT}		V_{dif1}		V_{dif2}	
$V_{OUT(T)}$ (V)	MIN.	MAX.	MIN.	MAX.	TYP.	MAX.	TYP.	MAX.
2.0	1.960	2.040	1.980	2.020	450	600	1900	2600
2.1	2.058	2.142	2.079	2.121	450	600	1900	2600
2.2	2.156	2.244	2.178	2.222	390	520	1700	2200
2.3	2.254	2.346	2.277	2.323	390	520	1700	2200
2.4	2.352	2.448	2.376	2.424	390	520	1700	2200
2.5	2.450	2.550	2.475	2.525	310	450	1500	1900
2.6	2.548	2.652	2.574	2.626	310	450	1500	1900
2.7	2.646	2.754	2.673	2.727	310	450	1500	1900
2.8	2.744	2.856	2.772	2.828	310	450	1500	1900
2.9	2.842	2.958	2.871	2.929	310	450	1500	1900
3.0	2.940	3.060	2.970	3.030	260	360	1300	1700
3.1	3.038	3.162	3.069	3.131	260	360	1300	1700
3.2	3.136	3.264	3.168	3.232	260	360	1300	1700
3.3	3.234	3.366	3.267	3.333	260	360	1300	1700
3.4	3.332	3.468	3.366	3.434	260	360	1300	1700
3.5	3.430	3.570	3.465	3.535	260	360	1300	1700
3.6	3.528	3.672	3.564	3.636	260	360	1300	1700
3.7	3.626	3.774	3.663	3.737	260	360	1300	1700
3.8	3.724	3.876	3.762	3.838	260	360	1300	1700
3.9	3.822	3.978	3.861	3.939	260	360	1300	1700
4.0	3.920	4.080	3.960	4.040	220	320	1100	1500
4.1	4.018	4.182	4.059	4.141	220	320	1100	1500
4.2	4.116	4.284	4.158	4.242	220	320	1100	1500
4.3	4.214	4.386	4.257	4.343	220	320	1100	1500
4.4	4.312	4.488	4.356	4.444	220	320	1100	1500
4.5	4.410	4.590	4.455	4.545	220	320	1100	1500
4.6	4.508	4.692	4.554	4.646	220	320	1100	1500
4.7	4.606	4.794	4.653	4.747	220	320	1100	1500
4.8	4.704	4.896	4.752	4.848	220	320	1100	1500
4.9	4.802	4.998	4.851	4.949	220	320	1100	1500

ELECTRICAL CHARACTERISTICS (Continued)

● Voltage Chart (Continued)

PARAMETER	E-0				E-1		E-2	
	OUTPUT VOLTAGE (V) 2% ACCURACY		OUTPUT VOLTAGE (V) 1% ACCURACY		DROPOUT VOLTAGE 1 (mV) $I_{OUT}=20mA$		DROPOUT VOLTAGE 2 (mV) $I_{OUT}=100mA$	
	$V_{OUT(T)}$ (V)	V_{OUT}		V_{OUT}		V_{dif1}		V_{dif2}
	MIN.	MAX.	MIN.	MAX.	TYP.	MAX.	TYP.	MAX.
5.0	4.900	5.100	4.950	5.050	190	280	1000	1300
5.1	4.998	5.202	5.049	5.151	190	280	1000	1300
5.2	5.096	5.304	5.148	5.252	190	280	1000	1300
5.3	5.194	5.406	5.247	5.353	190	280	1000	1300
5.4	5.292	5.508	5.346	5.454	190	280	1000	1300
5.5	5.390	5.610	5.445	5.555	190	280	1000	1300
5.6	5.488	5.712	5.544	5.656	190	280	1000	1300
5.7	5.586	5.814	5.643	5.757	190	280	1000	1300
5.8	5.684	5.916	5.742	5.916	190	280	1000	1300
5.9	5.782	6.018	5.841	5.959	190	280	1000	1300
6.0	5.880	6.120	5.940	6.060	190	280	1000	1300
6.1	5.978	6.222	6.039	6.161	190	280	1000	1300
6.2	6.076	6.324	6.138	6.262	190	280	1000	1300
6.3	6.174	6.426	6.237	6.363	190	280	1000	1300
6.4	6.272	6.528	6.336	6.464	190	280	1000	1300
6.5	6.370	6.630	6.435	6.565	170	230	800	1150
6.6	6.468	6.732	6.534	6.666	170	230	800	1150
6.7	6.566	6.834	6.633	6.767	170	230	800	1150
6.8	6.664	6.936	6.732	6.868	170	230	800	1150
6.9	6.762	7.038	6.831	6.969	170	230	800	1150
7.0	6.860	7.140	6.930	7.070	170	230	800	1150
7.1	6.958	7.242	7.029	7.171	170	230	800	1150
7.2	7.056	7.344	7.128	7.272	170	230	800	1150
7.3	7.154	7.446	7.227	7.373	170	230	800	1150
7.4	7.252	7.548	7.326	7.474	170	230	800	1150
7.5	7.350	7.650	7.425	7.575	170	230	800	1150
7.6	7.448	7.752	7.524	7.676	170	230	800	1150
7.7	7.546	7.854	7.623	7.777	170	230	800	1150
7.8	7.644	7.956	7.722	7.878	170	230	800	1150
7.9	7.742	8.058	7.821	7.979	170	230	800	1150
8.0	7.840	8.160	7.920	8.080	170	230	800	1150

ELECTRICAL CHARACTERISTICS (Continued)

● Voltage Chart (Continued)

PARAMETER	E-0				E-1		E-2	
	OUTPUT VOLTAGE (V) 2% ACCURACY		OUTPUT VOLTAGE (V) 1% ACCURACY		DROPOUT VOLTAGE 1 (mV) $I_{OUT}=20mA$		DROPOUT VOLTAGE 2 (mV) $I_{OUT}=100mA$	
	$V_{OUT(T)}$ (V)	V_{OUT}		V_{OUT}		V_{dif1}		V_{dif2}
	MIN.	MAX.	MIN.	MAX.	TYP.	MAX.	TYP.	MAX.
8.1	7.938	8.262	8.019	8.181	130	190	700	950
8.2	8.036	8.364	8.118	8.282	130	190	700	950
8.3	8.134	8.466	8.217	8.383	130	190	700	950
8.4	8.232	8.568	8.316	8.484	130	190	700	950
8.5	8.330	8.670	8.415	8.585	130	190	700	950
8.6	8.428	8.772	8.514	8.686	130	190	700	950
8.7	8.526	8.874	8.613	8.787	130	190	700	950
8.8	8.624	8.976	8.712	8.888	130	190	700	950
8.9	8.722	9.078	8.811	8.989	130	190	700	950
9.0	8.820	9.180	8.910	9.090	130	190	700	950
9.1	8.918	9.282	9.009	9.191	130	190	700	950
9.2	9.016	9.384	9.108	9.292	130	190	700	950
9.3	9.114	9.486	9.207	9.393	130	190	700	950
9.4	9.212	9.588	9.306	9.494	130	190	700	950
9.5	9.310	9.690	9.405	9.595	130	190	700	950
9.6	9.408	9.792	9.504	9.696	130	190	700	950
9.7	9.506	9.894	9.603	9.797	130	190	700	950
9.8	9.604	9.996	9.702	9.898	130	190	700	950
9.9	9.702	10.098	9.801	9.999	130	190	700	950
10.0	9.800	10.200	9.900	10.100	130	190	700	950
10.1	9.898	10.302	9.999	10.201	120	160	650	850
10.2	9.996	10.404	10.098	10.302	120	160	650	850
10.3	10.094	10.506	10.197	10.403	120	160	650	850
10.4	10.192	10.608	10.296	10.504	120	160	650	850
10.5	10.290	10.710	10.395	10.605	120	160	650	850
10.6	10.388	10.812	10.494	10.706	120	160	650	850
10.7	10.486	10.914	10.593	10.807	120	160	650	850
10.8	10.584	11.016	10.692	10.908	120	160	650	850
10.9	10.682	11.118	10.791	11.009	120	160	650	850
11.0	10.780	11.220	10.890	11.110	120	160	650	850
11.1	10.878	11.322	10.989	11.211	120	160	650	850
11.2	10.976	11.424	11.088	11.312	120	160	650	850
11.3	11.074	11.526	11.187	11.413	120	160	650	850
11.4	11.172	11.628	11.286	11.514	120	160	650	850
11.5	11.270	11.730	11.385	11.615	120	160	650	850
11.6	11.368	11.832	11.484	11.716	120	160	650	850
11.7	11.466	11.934	11.583	11.817	120	160	650	850
11.8	11.564	12.036	11.682	11.918	120	160	650	850
11.9	11.662	12.138	11.781	12.019	120	160	650	850
12.0	11.760	12.240	11.880	12.120	120	160	650	850

ELECTRICAL CHARACTERISTICS (Continued)

XE6216B Series

PARAMETER	SYMBOL	CONDITIONS	Ta=25°C			Ta=-40°C~85°C			UNITS	CIRCUIT
			MIN.	TYP.	MAX.	MIN.	TYP.	MAX.		
Output Voltage	V _{OUT(E)}	I _{OUT} =20mA, V _{CE} =V _{IN}	E-0-1			E-0-2			V	①
Maximum Output Current(*)	I _{OUTMAX}	V _{IN} =V _{OUT(T)} +3.0V, V _{CE} =V _{IN} (V _{OUT(T)} ≥3.0V)	-	-	-	150	-	-	mA	①
		V _{IN} =V _{OUT(T)} +3.0V, V _{CE} =V _{IN} (V _{OUT(T)} <3.0V)	-	-	-	100	-	-	mA	①
Load Regulation(*)	ΔV _{OUT}	V _{IN} =V _{OUT(T)} +2.0V, V _{CE} =V _{IN} 1mA≤I _{OUT} ≤50mA	E-1-1			E-1-2			mV	①
Dropout Voltage1	V _{dif1}	I _{OUT} =20mA, V _{CE} =V _{IN}	E-2-1			E-2-2			mV	①
Dropout Voltage2(*)	V _{dif2}	I _{OUT} =100mA, V _{CE} =V _{IN}	E-3-1			E-3-2			mV	①
Supply Current	I _{SS}	V _{CE} =V _{IN}	1	5	9	0.5	5	10	μA	②
Stand-by Current	I _{stby}	V _{CE} =V _{SS}	-	0.01	0.1	-	0.01	4	μA	②
Line Regulation1(*)	ΔV _{OUT} / ΔV _{IN} *V _{OUT(T)}	V _{OUT(T)} +2.0V≤V _{IN} ≤28.0V I _{OUT} =5mA, V _{CE} =V _{IN}	-	0.05	0.10	-	0.05	0.12	%/V	①
Line Regulation2(*)	ΔV _{OUT} / ΔV _{IN} *V _{OUT(T)}	V _{OUT(T)} +2.0V≤V _{IN} ≤28.0V I _{OUT} =13mA, V _{CE} =V _{IN}	-	0.15	0.30	-	0.15	0.32	%/V	①
Input Voltage	V _{IN}		2.0		28.0	2.0		28.0	V	
Output Voltage Temperature Characteristics	ΔV _{OUT} / ΔTa*V _{OUT(T)}	I _{OUT} =20mA, V _{CE} =V _{IN} -40°C≤Ta≤85°C	-	±100	±350	-	-	-	ppm/°C	①
Ripple Rejection Rate	PSRR	V _{IN} =[V _{OUT(T)} +2.0]V+0.5Vp-pAC, I _{OUT} =20mA, f=1kHz, V _{CE} =V _{IN}	-	30	-	-	30	-	dB	③
Short Current	I _{short}	V _{IN} =V _{OUT(T)} +2.0V, V _{CE} =V _{IN}	-	30	-	-	30	-	mA	①
CE "H" Level Voltage	V _{CEH}	V _{IN} =28.0V	-	-	-	1.1	-	28.0	V	①
CE "L" Level Voltage	V _{CEL}	V _{IN} =28.0V	-	-	-	0	-	0.35	V	①
CE "H" Level Current	I _{CEH}	V _{IN} =V _{CE} =28.0V	-0.1	-	0.1	-0.1	-	0.7	μA	②
CE "L" Level Current	I _{CEL}	V _{IN} =28.0V, V _{CE} =V _{SS}	-0.1	-	0.1	-0.2	-	-0.2	μA	②
Thermal Shutdown Detect Temperature	T _{TSD}	Junction Temperature	-	150	-	-	150	-	°C	①
Thermal Shutdown Release Temperature	T _{TSR}	Junction Temperature	-	125	-	-	125	-	°C	①
Hysteresis Width	T _{TSD} - T _{TSR}	Junction Temperature	-	25	-	-	25	-	°C	-

NOTE:

*1: V_{OUT(T)}: Specified output voltage

*2: V_{OUT(E)}: Effective output voltage

(i.e. the output voltage when "V_{OUT(T)}+2.0V" is provided at the V_{IN} pin while maintaining a certain I_{OUT} value.)

*3: V_{dif}={V_{IN1}(Note 5) - V_{OUT1}(Note 4)}

*4: V_{OUT1}: V_{OUT(T)} < 3.0V, A voltage equal to 98% of the output voltage whenever an amply stabilized I_{OUT}{V_{OUT(T)}+3.0V} is input.

V_{OUT(T)} 3.0V, A voltage equal to 98% of the output voltage whenever an amply stabilized I_{OUT}{V_{OUT(T)}+2.0V} is input.

*5: V_{IN1}: The input voltage when V_{OUT1} appears as input voltage is gradually decreased.

*6: Unless otherwise stated, V_{IN}=V_{OUT(T)}+2.0V.

() Junction temperature range is T_j=-40 ~ 125 for this table.

ELECTRICAL CHARACTERISTICS (Continued)

XE6216D Series Under Development

PARAMETER	SYMBOL	CONDITIONS	Ta=25°C			Ta=-40°C~85°C			UNITS	CIRCUIT
			MIN.	TYP.	MAX.	MIN.	TYP.	MAX.		
Output Voltage	V _{OUT(E)}	I _{OUT} =20mA	E-0-1			E-0-2			V	①
Maximum Output Current ^(*)	I _{OUTMAX}	V _{IN} =V _{OUT(T)} +3.0V (V _{OUT(T)} ≥3.0V)	-	-	-	150	-	-	mA	①
		V _{IN} =V _{OUT(T)} +3.0V (V _{OUT(T)} <3.0V)	-	-	-	100	-	-	mA	①
Load Regulation ^(*)	ΔV _{OUT}	V _{IN} =V _{OUT(T)} +2.0V 1mA≤I _{OUT} ≤50mA	E-1-1			E-1-2			mV	①
Dropout Voltage1	Vdif1	I _{OUT} =20mA	E-2-1			E-2-2			mV	①
Dropout Voltage2 ^(*)	Vdif2	I _{OUT} =100mA	E-3-1			E-3-2			mV	①
Supply Current	I _{SS}		1	5	9	0.5	5	10	μA	②
Line Regulation1 ^(*)	$\frac{\Delta V_{OUT}}{\Delta V_{IN} \cdot V_{OUT(T)}}$	V _{OUT(T)} +2.0V≤V _{IN} ≤28.0V I _{OUT} =5mA	-	0.05	0.10	-	0.05	0.12	%/V	①
Line Regulation2 ^(*)	$\frac{\Delta V_{OUT}}{\Delta V_{IN} \cdot V_{OUT(T)}}$	V _{OUT(T)} +2.0V≤V _{IN} ≤28.0V I _{OUT} =13mA	-	0.15	0.30	-	0.15	0.32	%/V	①
Input Voltage	V _{IN}		2.0		28.0	2.0		28.0	V	
Output Voltage Temperature Characteristics	$\frac{\Delta V_{OUT}}{\Delta T_a \cdot V_{OUT(T)}}$	I _{OUT} =20mA -40°C≤Ta≤85°C	-	±100	±350	-	-	-	ppm/°C	①
Ripple Rejection Rate	PSRR	V _{IN} =[V _{OUT(T)} +2.0]V+0.5Vp-pAC, I _{OUT} =20mA, f=1kHz	-	30	-	-	30	-	dB	③
Short Current	I _{short}	V _{IN} =V _{OUT(T)} +2.0V	-	30	-	-	30	-	mA	①
Thermal Shutdown Detect Temperature	T _{TSD}	Junction Temperature	-	150	-	-	150	-	°C	①
Thermal Shutdown Release Temperature	T _{TSR}	Junction Temperature	-	125	-	-	125	-	°C	①
Hysteresis Widht	T _{TSD} - T _{TSR}	Junction Temperature	-	25	-	-	25	-	°C	-

NOTE:

*1: V_{OUT(T)}: Specified output voltage

*2: V_{OUT(E)}: Effective output voltage

(i.e. the output voltage when "V_{OUT(T)}+2.0V" is provided at the V_{IN} pin while maintaining a certain I_{OUT} value.)

*3: Vdif={V_{IN1}^(Note 5) - V_{OUT1}^(Note 4)}

*4: V_{OUT1}: V_{OUT(T)} < 3.0V, A voltage equal to 98% of the output voltage whenever an amply stabilized I_{OUT}{V_{OUT(T)}+3.0V} is input.

V_{OUT(T)} = 3.0V, A voltage equal to 98% of the output voltage whenever an amply stabilized I_{OUT}{V_{OUT(T)}+2.0V} is input.

*5: V_{IN1}: The input voltage when V_{OUT1} appears as input voltage is gradually decreased.

*6: Unless otherwise stated, V_{IN}=V_{OUT(T)}+2.0V.

() Junction temperature range is T_j=-40 ~ 125 for this table.

ELECTRICAL CHARACTERISTICS (Continued)

Voltage Chart 1 (XE6216 Series)

SYMBOL	E-0-1		E-0-2	
Temperature / Ta	25		-40 ~ 85	
PARAMETER	OUTPUT VOLTAGE (V) Accuracy ±2%		OUTPUT VOLTAGE (V) Accuracy +3% , -3.5%	
NOMINAL OUTPUT VOLTAGE	V _{OUT}		V _{OUT}	
V _{OUT(T)} (V)	MIN.	MAX.	MIN.	MAX.
2.0	1.960	2.040	1.930	2.060
2.1	2.058	2.142	2.027	2.163
2.2	2.156	2.244	2.123	2.266
2.3	2.254	2.346	2.220	2.369
2.4	2.352	2.448	2.316	2.472
2.5	2.450	2.550	2.413	2.575
2.6	2.548	2.652	2.509	2.678
2.7	2.646	2.754	2.606	2.781
2.8	2.744	2.856	2.702	2.884
2.9	2.842	2.958	2.799	2.987
3.0	2.940	3.060	2.895	3.090
3.1	3.038	3.162	2.992	3.193
3.2	3.136	3.264	3.088	3.296
3.3	3.234	3.366	3.185	3.399
3.4	3.332	3.468	3.281	3.502
3.5	3.430	3.570	3.378	3.605
3.6	3.528	3.672	3.474	3.708
3.7	3.626	3.774	3.571	3.811
3.8	3.724	3.876	3.667	3.914
3.9	3.822	3.978	3.764	4.017
4.0	3.920	4.080	3.860	4.120
4.1	4.018	4.182	3.957	4.223
4.2	4.116	4.284	4.053	4.326
4.3	4.214	4.386	4.150	4.429
4.4	4.312	4.488	4.246	4.532
4.5	4.410	4.590	4.342	4.635
4.6	4.508	4.692	4.439	4.738
4.7	4.606	4.794	4.535	4.841
4.8	4.704	4.896	4.632	4.944
4.9	4.802	4.998	4.728	5.047

SYMBOL	E-0-1		E-0-2	
Temperature / Ta	25		-40 ~ 85	
PARAMETER	OUTPUT VOLTAGE (V) Accuracy ±2%		OUTPUT VOLTAGE (V) Accuracy +3% , -3.5%	
NOMINAL OUTPUT VOLTAGE	V _{OUT}		V _{OUT}	
V _{OUT(T)} (V)	MIN.	MAX.	MIN.	MAX.
5.0	4.900	5.100	4.825	5.150
5.1	4.998	5.202	4.921	5.253
5.2	5.096	5.304	5.018	5.356
5.3	5.194	5.406	5.114	5.459
5.4	5.292	5.508	5.211	5.562
5.5	5.390	5.610	5.307	5.665
5.6	5.488	5.712	5.404	5.768
5.7	5.586	5.814	5.500	5.871
5.8	5.684	5.916	5.597	5.974
5.9	5.782	6.018	5.693	6.077
6.0	5.880	6.120	5.790	6.180
6.1	5.978	6.222	5.886	6.283
6.2	6.076	6.324	5.983	6.386
6.3	6.174	6.426	6.079	6.489
6.4	6.272	6.528	6.176	6.592
6.5	6.370	6.630	6.272	6.695
6.6	6.468	6.732	6.369	6.798
6.7	6.566	6.834	6.465	6.901
6.8	6.664	6.936	6.562	7.004
6.9	6.762	7.038	6.658	7.107
7.0	6.860	7.140	6.755	7.210
7.1	6.958	7.242	6.851	7.313
7.2	7.056	7.344	6.948	7.416
7.3	7.154	7.446	7.044	7.519
7.4	7.252	7.548	7.141	7.622
7.5	7.350	7.650	7.237	7.725
7.6	7.448	7.752	7.334	7.828
7.7	7.546	7.854	7.430	7.931
7.8	7.644	7.956	7.527	8.034
7.9	7.742	8.058	7.623	8.137

ELECTRICAL CHARACTERISTICS (Continued)

Voltage Chart 2 (XE6216 Series)

SYMBOL	E-0-1		E-0-2	
Temperature /Ta	25		-40 ~ 85	
PARAMETER	OUTPUT VOLTAGE (V) Accuracy $\pm 2\%$		OUTPUT VOLTAGE (V) Accuracy +3% , -3.5%	
NOMINAL OUTPUT VOLTAGE				
V _{OUT(T)} (V)	V _{OUT}		V _{OUT}	
	MIN.	MAX.	MIN.	MAX.
8.0	7.840	8.160	7.720	8.240
8.1	7.938	8.262	7.816	8.343
8.2	8.036	8.364	7.913	8.446
8.3	8.134	8.466	8.009	8.549
8.4	8.232	8.568	8.106	8.652
8.5	8.330	8.670	8.202	8.755
8.6	8.428	8.772	8.299	8.858
8.7	8.526	8.874	8.395	8.961
8.8	8.624	8.976	8.492	9.064
8.9	8.722	9.078	8.588	9.167
9.0	8.820	9.180	8.685	9.270
9.1	8.918	9.282	8.781	9.373
9.2	9.016	9.384	8.878	9.476
9.3	9.114	9.486	8.974	9.579
9.4	9.212	9.588	9.071	9.682
9.5	9.310	9.690	9.167	9.785
9.6	9.408	9.792	9.264	9.888
9.7	9.506	9.894	9.360	9.991
9.8	9.604	9.996	9.457	10.094
9.9	9.702	10.098	9.553	10.197
10.0	9.800	10.200	9.650	10.300
10.1	9.898	10.302	9.747	10.403
10.2	9.996	10.404	9.843	10.506
10.3	10.094	10.506	9.940	10.609
10.4	10.192	10.608	10.036	10.712
10.5	10.290	10.710	10.133	10.815
10.6	10.388	10.812	10.229	10.918
10.7	10.486	10.914	10.326	11.021
10.8	10.584	11.016	10.422	11.124
10.9	10.682	11.118	10.519	11.227
11.0	10.780	11.220	10.615	11.330
11.1	10.878	11.322	10.712	11.433
11.2	10.976	11.424	10.808	11.536
11.3	11.074	11.526	10.905	11.639
11.4	11.172	11.628	11.001	11.742
11.5	11.270	11.730	11.098	11.845
11.6	11.368	11.832	11.194	11.948
11.7	11.466	11.934	11.291	12.051
11.8	11.564	12.036	11.387	12.154
11.9	11.662	12.138	11.484	12.257
12.0	11.760	12.240	11.580	12.360

ELECTRICAL CHARACTERISTICS (Continued)

Voltage Chart 3 (XE6216 Series)

SYMBOL	E-1-1		E-1-2		E-2-1		E-2-2		E-3-1		E-3-2					
Temperature /Ta	25°C		-40~85°C		25°C		-40~85°C		25°C		-40~85°C					
PARAMETER	LOAD REGULATION (mV)		LOAD REGULATION (mV)		DROPOUT VOLTAGE 1 (mV) I _{OUT} =20mA		DROPOUT VOLTAGE 1 (mV) I _{OUT} =20mA		DROPOUT VOLTAGE 2 (mV) I _{OUT} =100mA		DROPOUT VOLTAGE 2 (mV) I _{OUT} =100mA					
NOMINAL OUTPUT VOLTAGE																
V _{OUT(T)} (V)	ΔV _{OUT}		ΔV _{OUT}		Vdif1		Vdif1		Vdif2		Vdif2					
	TYP.	MAX.	TYP.	MAX.	TYP.	MAX.	TYP.	MAX.	TYP.	MAX.	TYP.	MAX.				
2.0	50	90	50	103	450	600	450	735	1900	2600	1900	3060				
2.1																
2.2																
2.3									390	520	390	675	1700	2200	1700	2760
2.4																
2.5																
2.6																
2.7									310	450	310	620	1500	1900	1500	2620
2.8																
2.9																
3.0																
3.1																
3.2																
3.3																
3.4									260	360	260	520	1300	1700	1300	2370
3.5																
3.6																
3.7																
3.8																
3.9																
4.0																
4.1																
4.2																
4.3																
4.4																
4.5					220	320	220	410	1100	1500	1100	2045				
4.6																
4.7																
4.8																
4.9																

ELECTRICAL CHARACTERISTICS (Continued)

Voltage Chart 4 (XE6216 Series)

SYMBOL	E-1-1		E-1-2		E-2-1		E-2-2		E-3-1		E-3-2	
Temperature / Ta	25°C		-40~85°C		25°C		-40~85°C		25°C		-40~85°C	
PARAMETER	LOAD REGULATION (mV)		LOAD REGULATION (mV)		DROPOUT VOLTAGE 1 (mV) I _{OUT} =20mA		DROPOUT VOLTAGE 1 (mV) I _{OUT} =20mA		DROPOUT VOLTAGE 2 (mV) I _{OUT} =100mA		DROPOUT VOLTAGE 2 (mV) I _{OUT} =100mA	
NOMINAL OUTPUT VOLTAGE												
V _{OUT(T)} (V)	ΔV _{OUT}		ΔV _{OUT}		Vdif1		Vdif1		Vdif2		Vdif2	
	TYP.	MAX.	TYP.	MAX.	TYP.	MAX.	TYP.	MAX.	TYP.	MAX.	TYP.	MAX.
5.0	50	90	50	103	190	280	190	380	1000	1300	1000	1730
5.1												
5.2												
5.3												
5.4												
5.5												
5.6												
5.7												
5.8												
5.9												
6.0	110	140	110	150	170	230	170	340	800	1150	800	1580
6.1												
6.2												
6.3												
6.4												
6.5												
6.6												
6.7												
6.8												
6.9												
7.0												
7.1												
7.2												
7.3												
7.4												
7.5												
7.6												
7.7												
7.8												
7.9												
8.0												

ELECTRICAL CHARACTERISTICS (Continued)

Voltage Chart 5 (XE6216 Series)

SYMBOL	E-1-1		E-1-2		E-2-1		E-2-2		E-3-1		E-3-2	
Temperature / Ta	25°C		-40~85°C		25°C		-40~85°C		25°C		-40~85°C	
PARAMETER	LOAD REGULATION (mV)		LOAD REGULATION (mV)		DROPOUT VOLTAGE 1 (mV) I _{OUT} =20mA		DROPOUT VOLTAGE 1 (mV) I _{OUT} =20mA		DROPOUT VOLTAGE 2 (mV) I _{OUT} =100mA		DROPOUT VOLTAGE 2 (mV) I _{OUT} =100mA	
NOMINAL OUTPUT VOLTAGE												
V _{OUT(T)} (V)	ΔV _{OUT}		ΔV _{OUT}		V _{dif1}		V _{dif1}		V _{dif2}		V _{dif2}	
	TYP.	MAX.	TYP.	MAX.	TYP.	MAX.	TYP.	MAX.	TYP.	MAX.	TYP.	MAX.
8.1	110	140	110	150	130	190	130	320	700	950	700	1460
8.2												
8.3												
8.4												
8.5												
8.6												
8.7												
8.8												
8.9												
9.0												
9.1												
9.2												
9.3												
9.4												
9.5												
9.6												
9.7												
9.8												
9.9												
10.0												
10.1	120	160	120	285	650	850	650	1160				
10.2												
10.3												
10.4												
10.5												
10.6												
10.7												
10.8												
10.9												
11.0												
11.1												
11.2												
11.3												
11.4												
11.5												
11.6												
11.7												
11.8												
11.9												
12.0												

OPERATIONAL EXPLANATION

<Output Voltage Control>

The voltage divided by resistors R11 & R12 is compared with the internal reference voltage by the error amplifier. The P-channel MOSFET which is connected to the V_{OUT} pin is then driven by the subsequent output signal. The output voltage at the V_{OUT} pin is controlled and stabilized by a system of negative feedback. The current limit circuit and short protect circuit operate in relation to the level of output current and heat dissipation. Further, the IC's internal circuitry can be shutdown via the CE pin's signal.

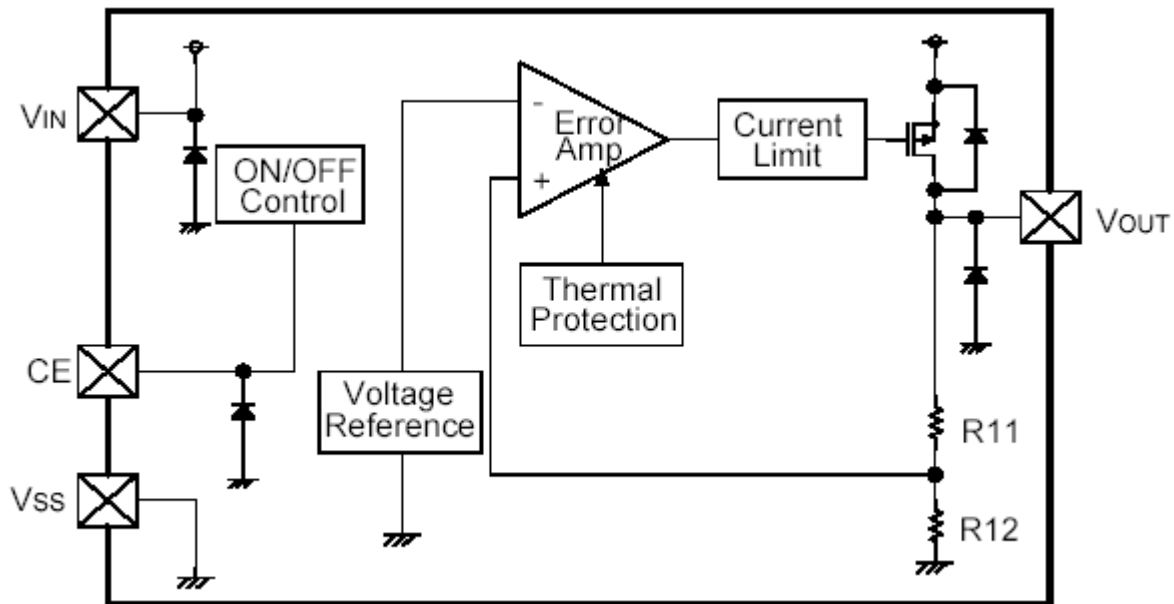

<Short-Circuit Protection>

The XC6216/XE6216 series includes a current fold-back circuit as a short circuit protection. When the load current reaches the current limit level, the current fold-back circuit operates and output voltage drops. The output voltage drops further and output current decreases. When the output pin is shorted, a current of about 30mA flows.

<CE Pin>

The IC's internal circuitry can be shutdown via the signal from the CE pin with the XC6216/XE6216 series. In shutdown mode, output at the V_{OUT} pin will be pulled down by R11 and R12 to the V_{SS} level. Note that as the XC6216/XE6216 series is 'High Active/No pull down', operations will become unstable with the CE pin open. We suggest that you use this IC with either a V_{IN} voltage or a V_{SS} voltage input at the CE pin. If this IC is used with the correct specifications for the CE pin, the operational logic is fixed and the IC will operate normally. However, supply current may increase as a result of through current in the IC's internal circuitry if a medium voltage is applied.

<Thermal Shutdown>

When the junction temperature of the built-in driver transistor reaches the temperature limit level (150 °C TYP.), the thermal shutdown circuit operates and the driver transistor will be set to OFF. The IC resumes its operation when the thermal shutdown function is released and the IC's operation is automatically restored because the junction temperature drops to the level of the thermal shutdown release voltage.

<Minimum Operating Voltage>

For the stable operation of the IC, over 2.0V of input voltage is necessary. The output voltage may not be generated normally if the input voltage is less than 2.0V.

NOTES ON USE

1. Please use this IC within the stated absolute maximum ratings. The IC is liable to malfunction should the ratings be exceeded.
2. Where wiring impedance is high, operations may become unstable due to the noise and/or phase lag depending on output current. Please strengthen V_{IN} and V_{SS} wiring in particular.
3. Phase compensation inside the IC is performed in the XC6216/XE6216 series. Therefore, an abnormal oscillation does not occur even if there is no output capacitor C_L . An input capacitor C_{IN} around 0.1 μ F~1.0 μ F between the V_{IN} pin and the V_{SS} pin is required for input stability. Also, the output voltage fluctuation such as under shoot or over shoot, which occurs because of the load change can be controlled by placing the output capacitor C_L around 0.1 μ F~1.0 μ F between the V_{OUT} pin and V_{SS} pin. The input capacitor (C_{IN}) and the output capacitor (C_L) should be placed to the IC as close as possible with a shorter wiring.
4. Notes on Setting Output Voltage Externally (C type) $T_a=25$

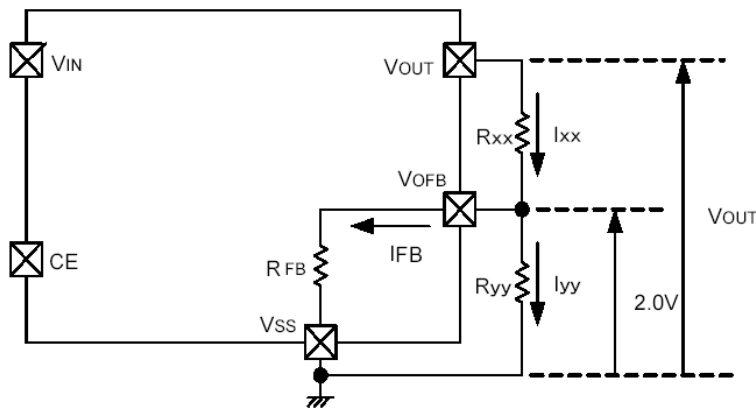

The output voltage can be set externally by the following equation:

$$V_{OUT} = 2.0V \times (R_{XX} + R_{YY}) / R_{YY} \quad (1)$$

Although the output voltage can be set freely by the above equation, resistance values can be calculated by the following equations in case considering output voltage accuracy.

$$I_{XX} = I_{FB} + I_{YY} \quad (2)$$

$$I_{YY} = 2.0V / R_{YY} \quad (3)$$

If the equation (3) is assigned to the equation (2), the equation becomes as below:

$$I_{XX} = I_{FB} + 2.0V / R_{YY} \quad (4)$$

For this, the following equation can be used for setting output voltage externally:

$$V_{OUT} = 2.0V + R_{XX} \cdot I_{XX} \quad (5)$$

And the equation (4) will be;

$$\begin{aligned} V_{OUT} &= 2.0V + R_{XX} \cdot (I_{FB} + 2.0V / R_{YY}) \\ &= 2.0V \times (1 + R_{XX} / R_{YY}) + R_{XX} \cdot I_{FB} \end{aligned} \quad (6)$$

The second term of the equation (6), $R_{XX} \cdot I_{FB}$, is the cause of the output accuracy error.

The I_{FB} can be calculated by the following equation:

$$I_{FB} = 2.0V / R_{FB} \quad (7)$$

The cause of the output accuracy error, $R_{XX} \cdot I_{FB}$ can be calculated by the equation below;

$$\begin{aligned} R_{XX} \cdot I_{FB} &= R_{XX} \cdot 2.0V / R_{FB} \\ &= 2.0V \times R_{XX} \cdot R_{FB} \end{aligned} \quad (8)$$

Accordingly, if R_{XX} is smaller than R_{FB} , the output voltage error becomes minute.

Setting Resistance-Dependant of XC6216 Series' Output Voltage

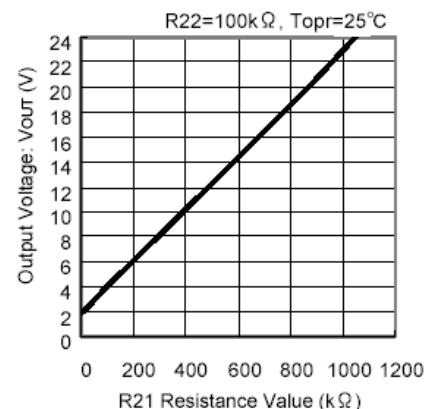
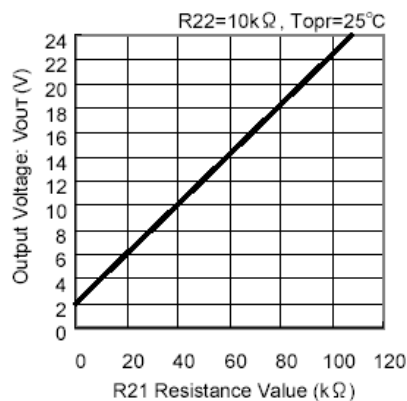
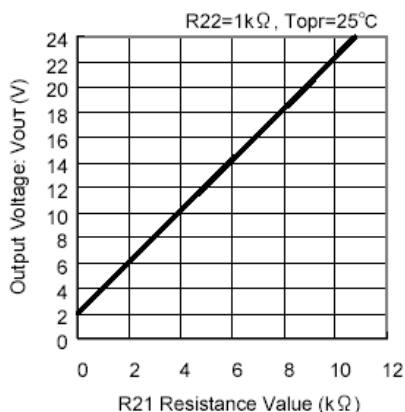

TEST CIRCUITS

Circuit

XC6216B/XE6216B Series

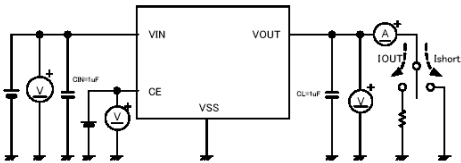

XC6216C/XE6216C Series

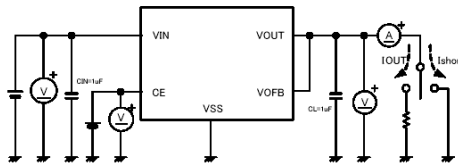

XC6216D/XE6216D Series

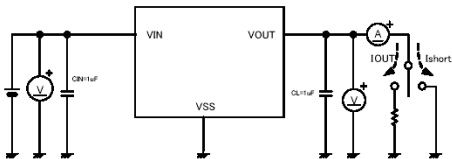

Circuit

XC6216B/XE6216B Series

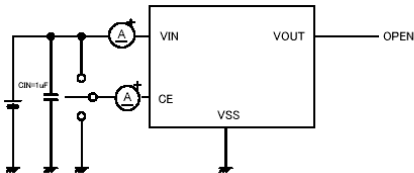

XC6216C/XE6216C Series

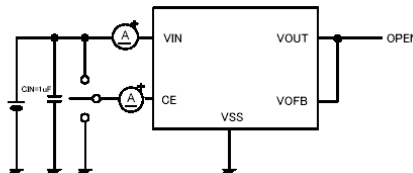

XC6216D/XE6216D Series

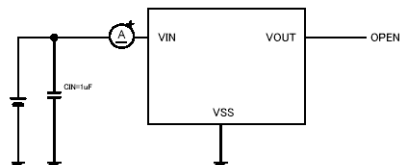

Circuit

XC6216B/XE6216B Series

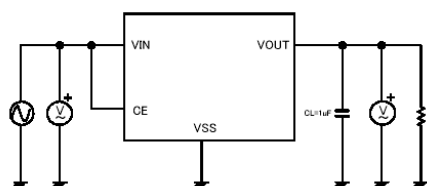

XC6216C/XE6216C Series

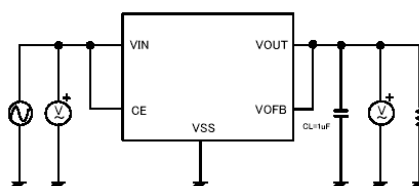

XC6216D/XE6216D Series

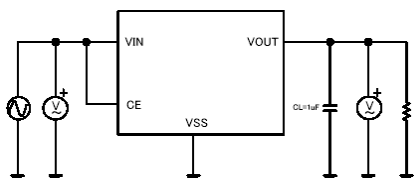

Circuit

XC6216C/XE6216C Series

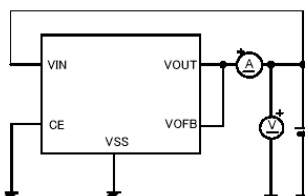

TYPICAL PERFORMANCE CHARACTERISTICS

(1) Output Voltage vs. Output Current

XC6216B/C/D 202

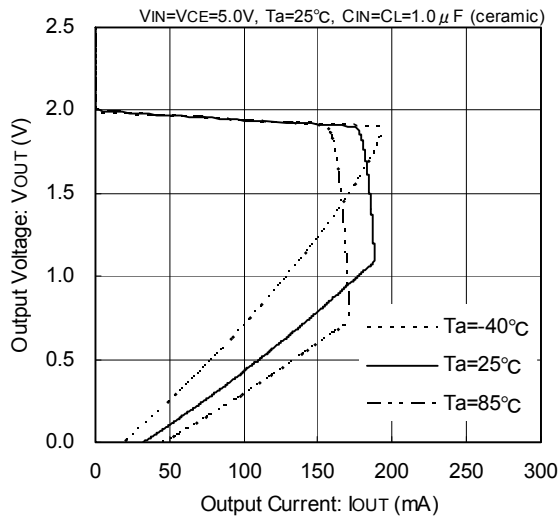

XC6216B/C/D 202

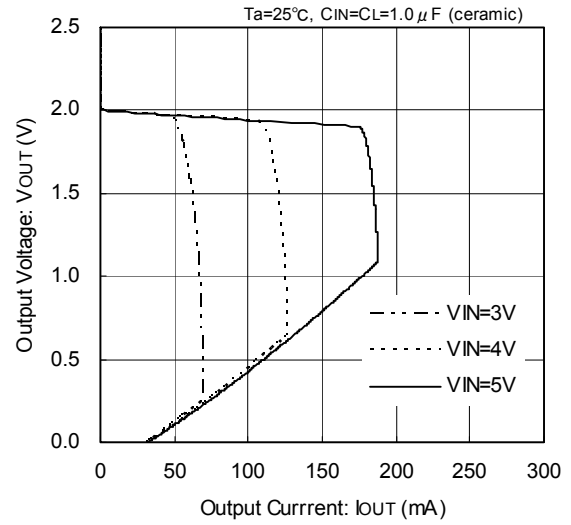

XC6216B/D 332

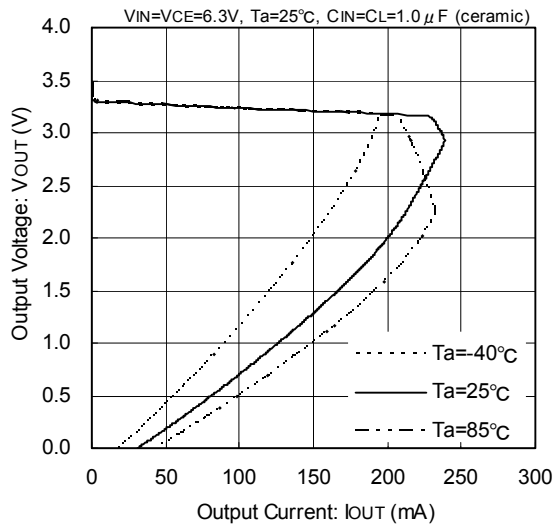

XC6216B/D 332

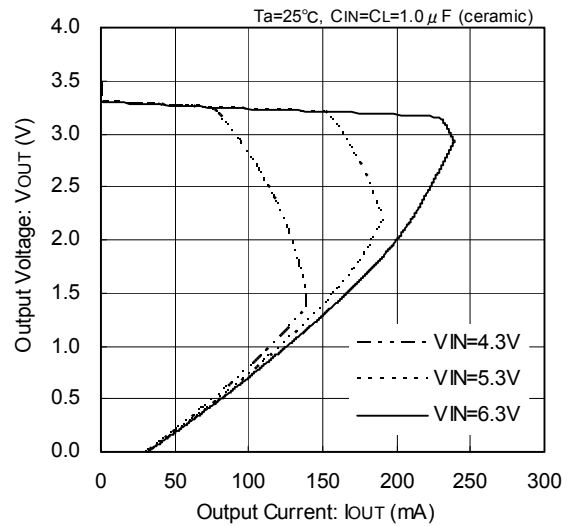

XC6216B/D 502

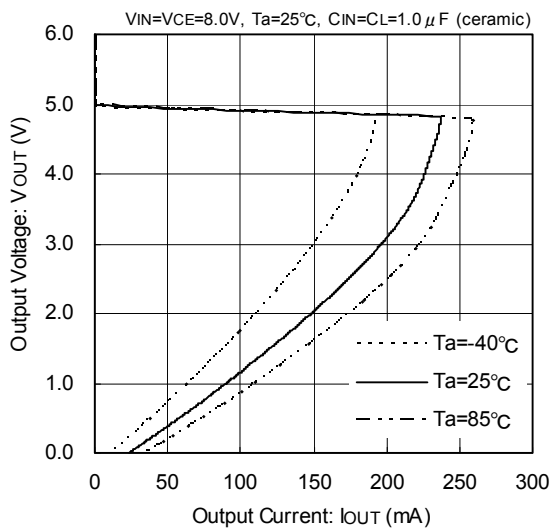

XC6216B/D 502

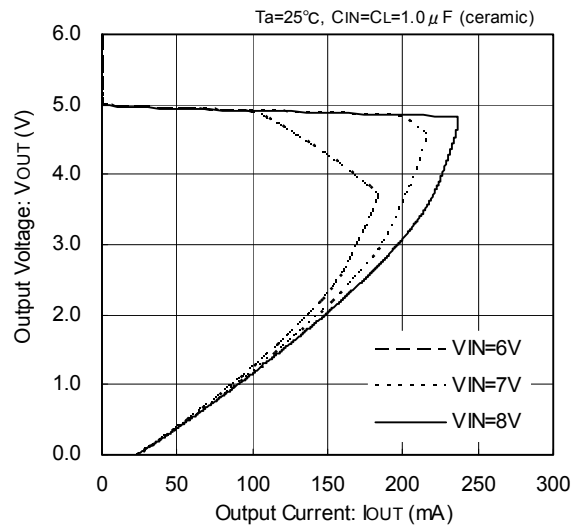

TYPICAL PERFORMANCE CHARACTERISTICS (Continued)

(1) Output Voltage vs. Output Current (Continued)

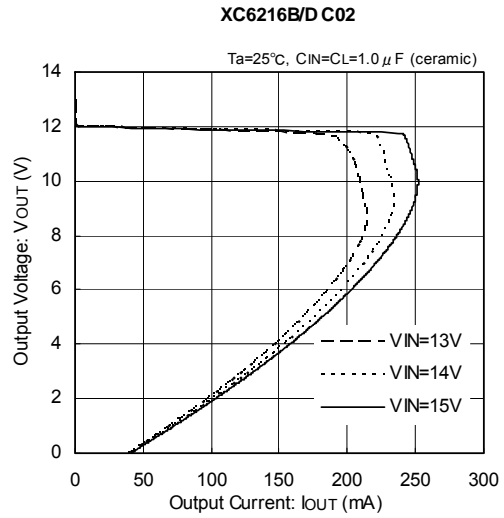
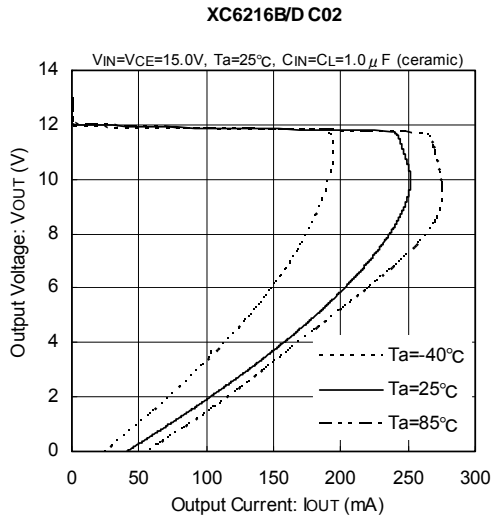

(2) Output Voltage vs. Input Voltage

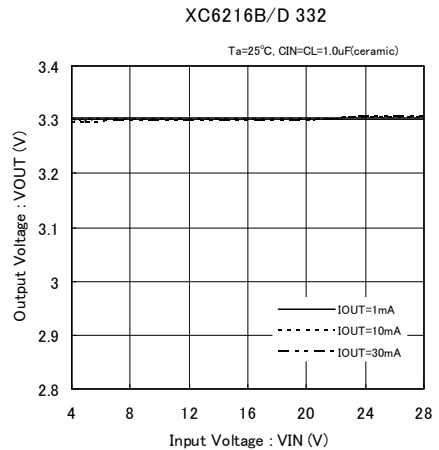
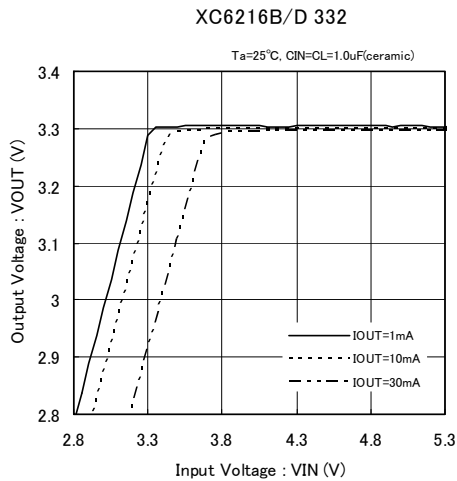
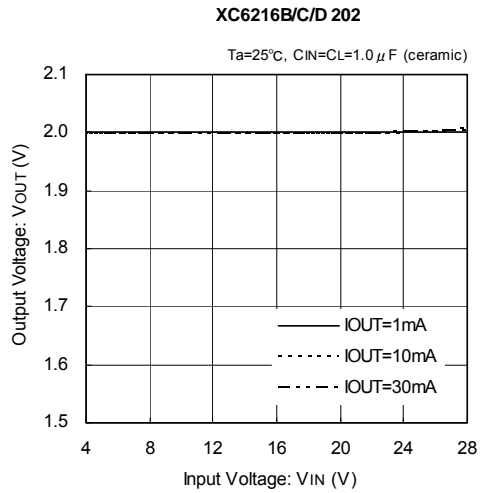
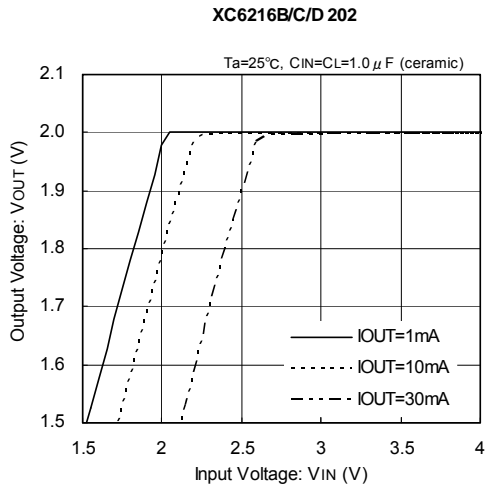

TYPICAL PERFORMANCE CHARACTERISTICS (Continued)

(2) Output Voltage vs. Input Voltage (Continued)

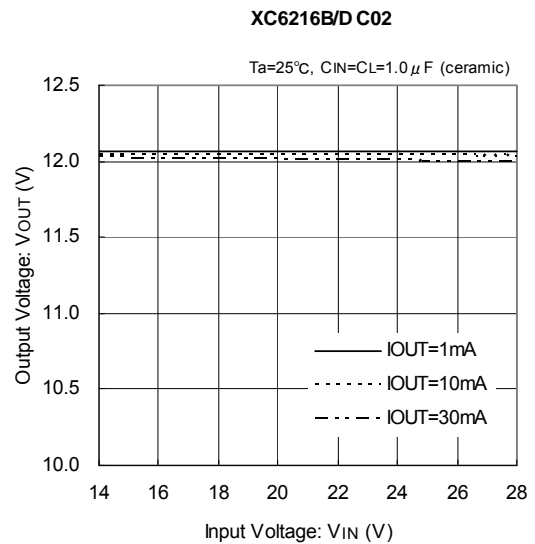
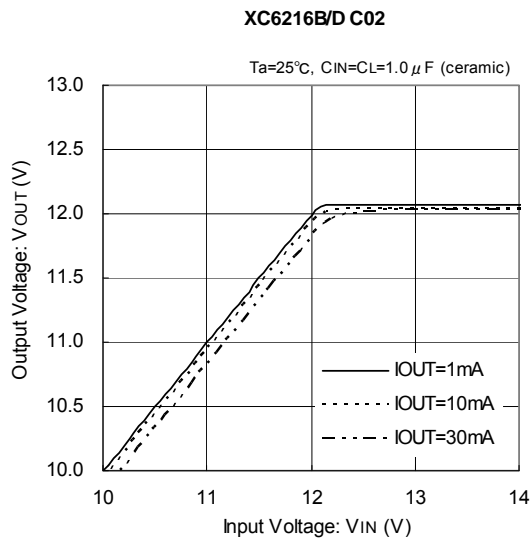
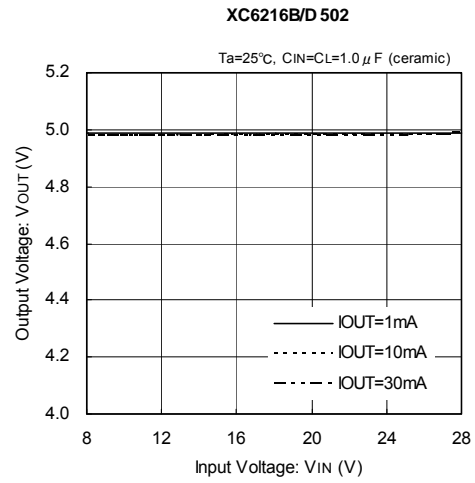
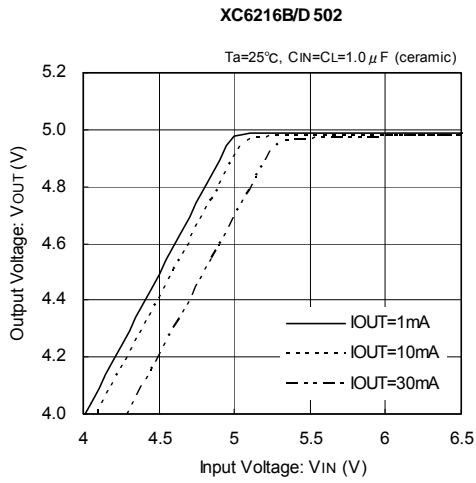

(3) Dropout Voltage vs. Output Current

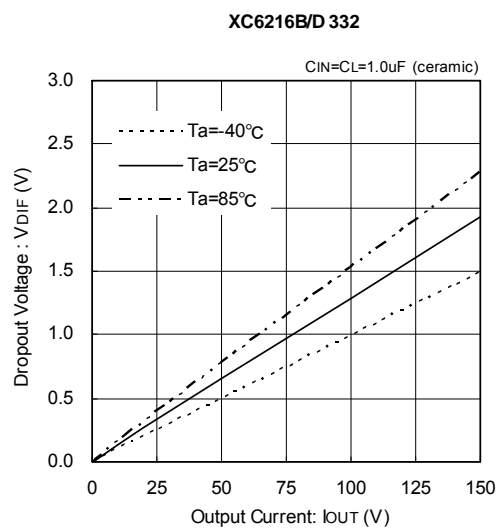
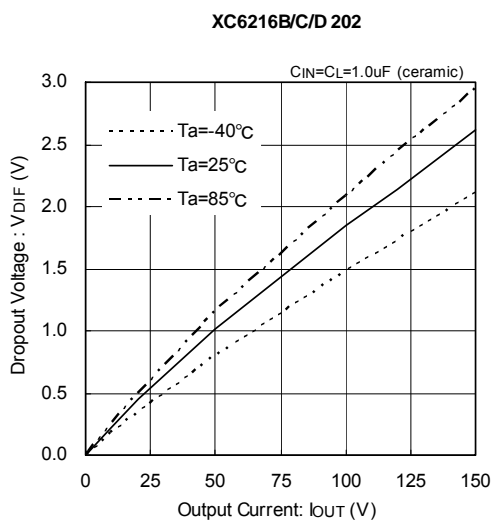

TYPICAL PERFORMANCE CHARACTERISTICS (Continued)

(3) Dropout Voltage vs. Output Current

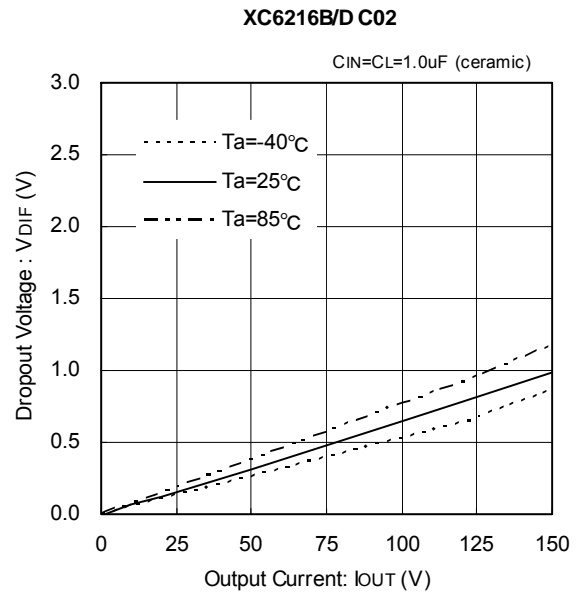
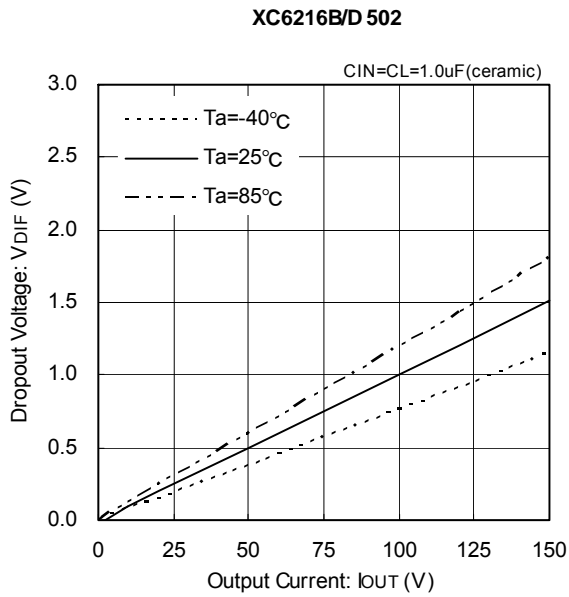

(4) Supply Current vs. Input Voltage

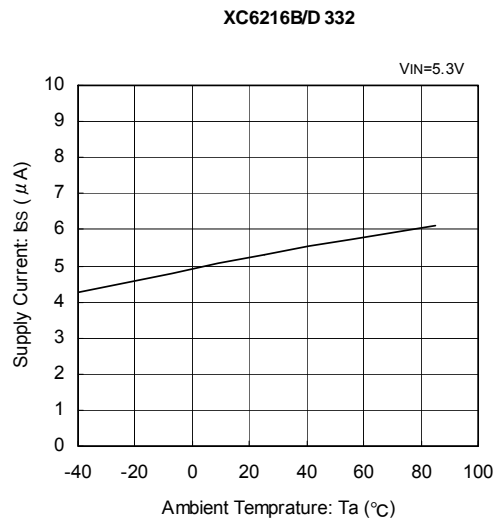
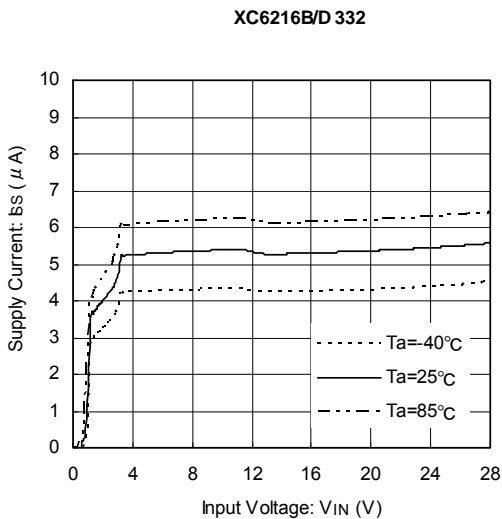
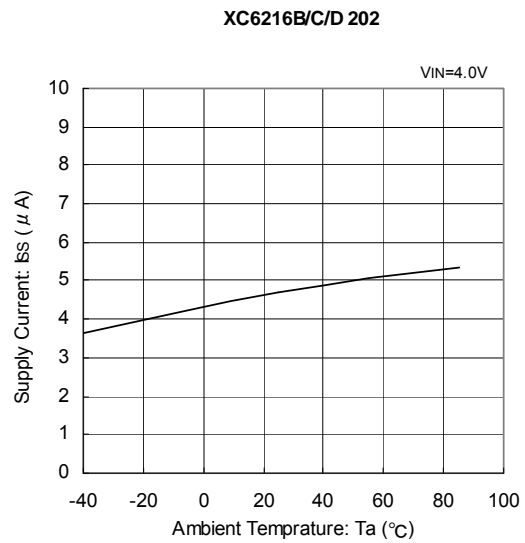
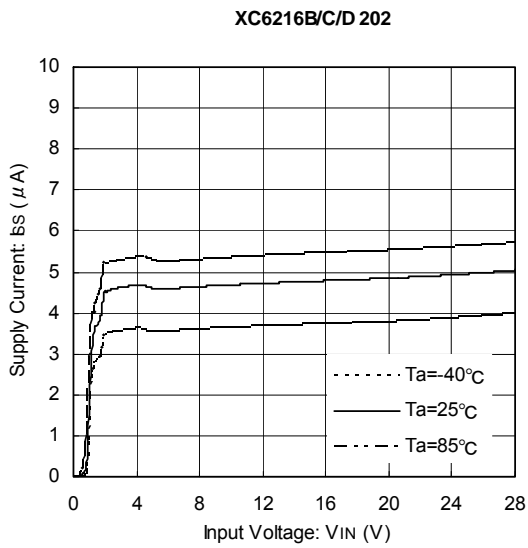

TYPICAL PERFORMANCE CHARACTERISTICS (Continued)

(4) Supply Current vs. Input Voltage (Continued)

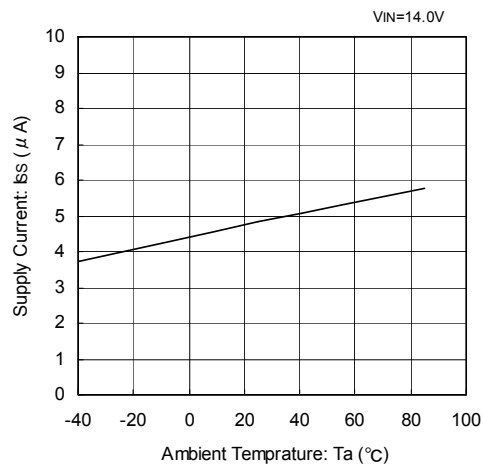
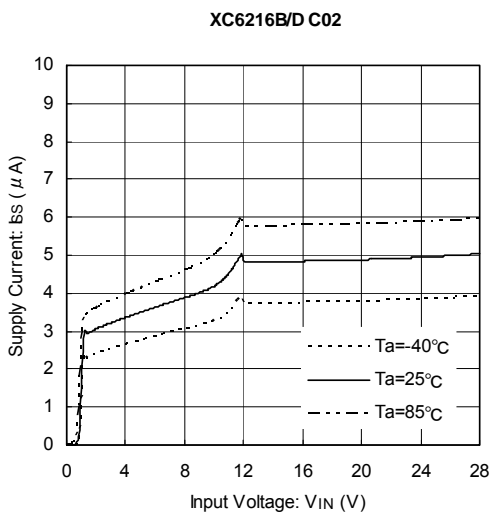
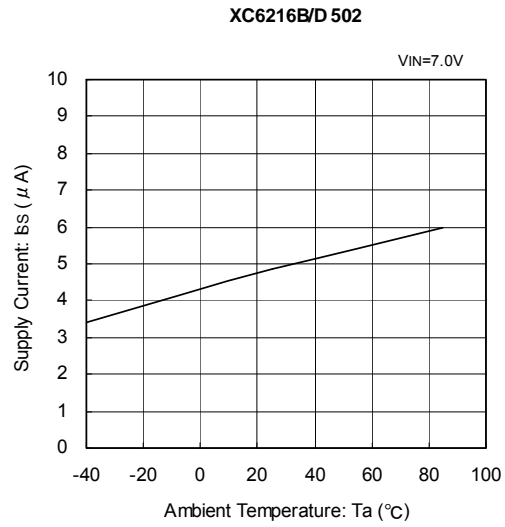
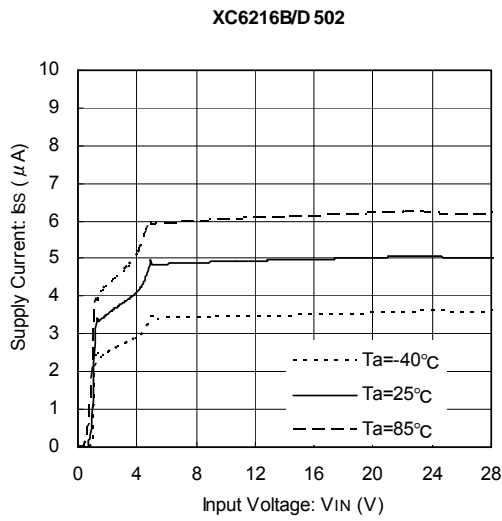

(5) Output Voltage vs. Ambient Temperature

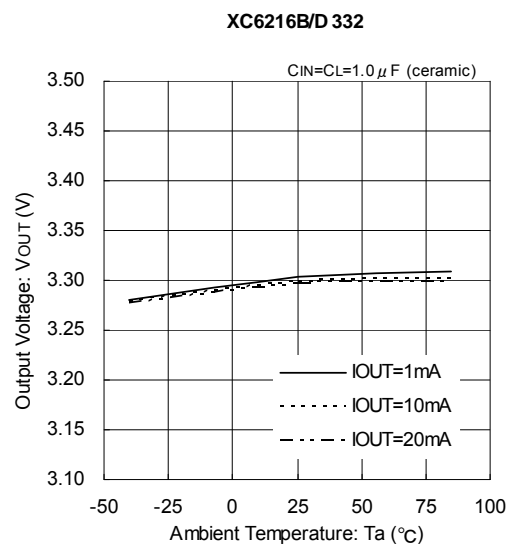
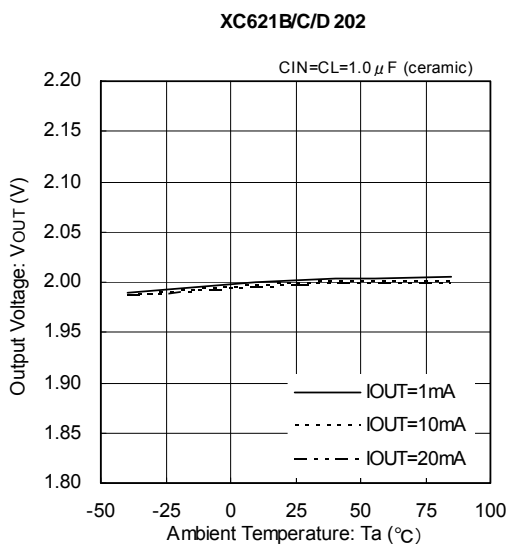

TYPICAL PERFORMANCE CHARACTERISTICS (Continued)

(5) Output Voltage vs. Ambient Temperature

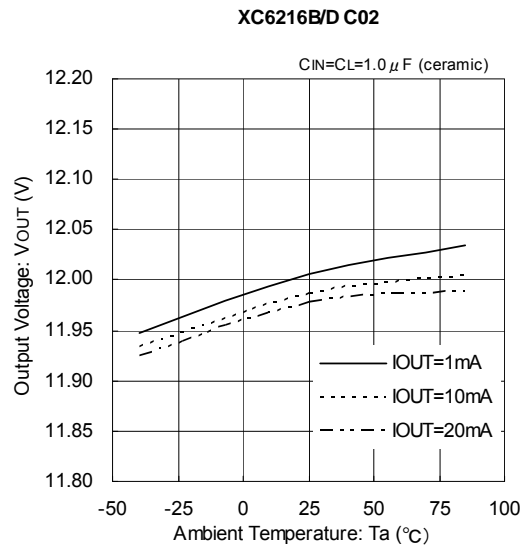
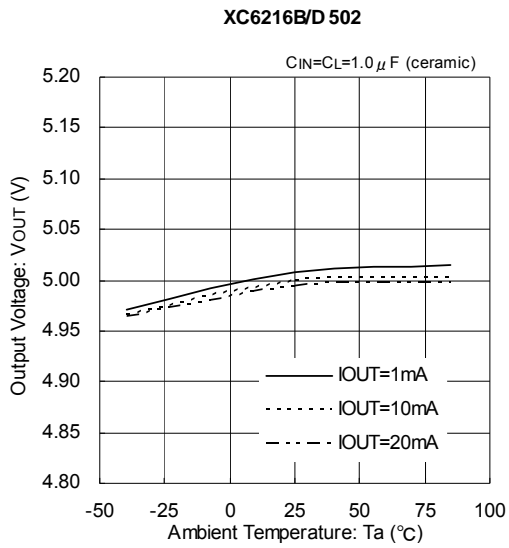

(6) Line Transient Response

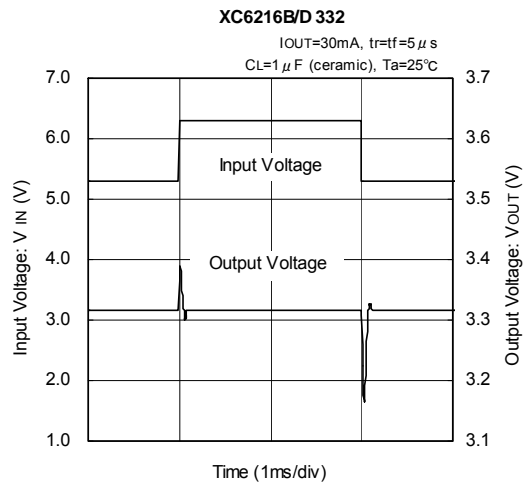
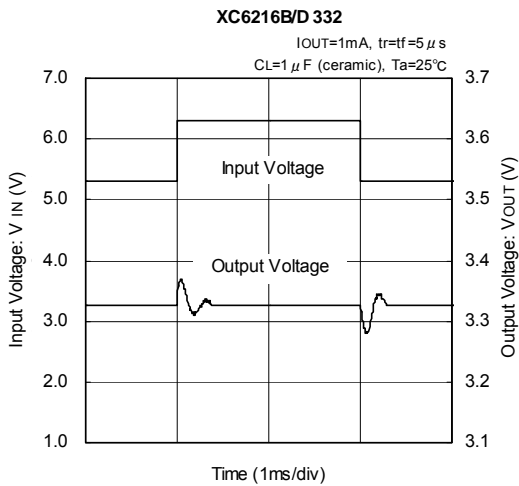
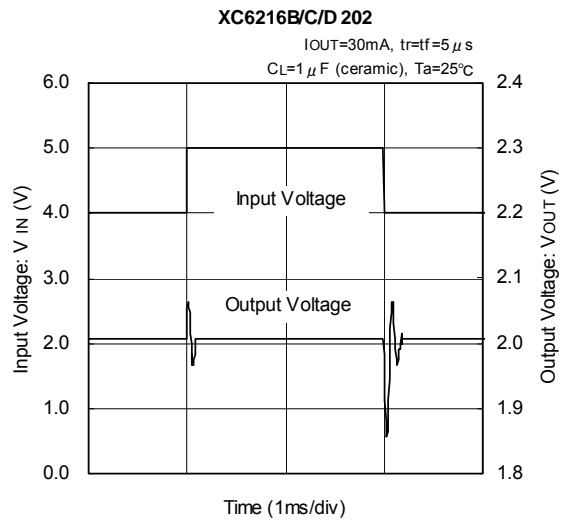
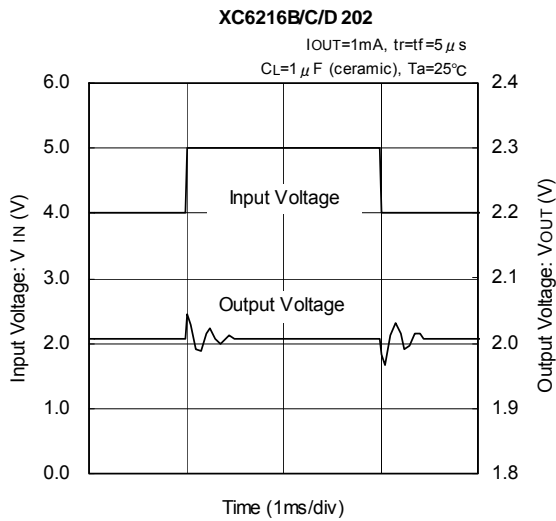

TYPICAL PERFORMANCE CHARACTERISTICS (Continued)

(6) Line Transient Response (Continued)

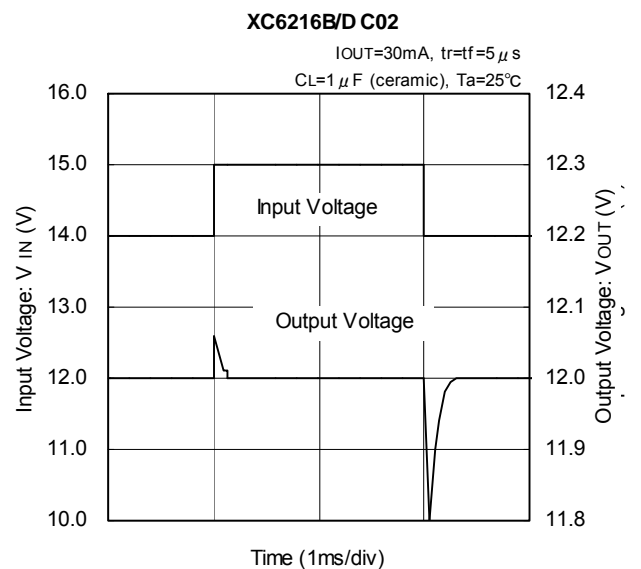
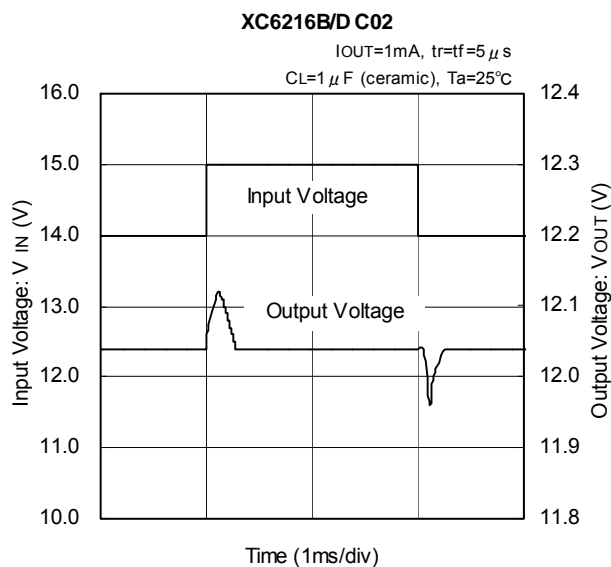
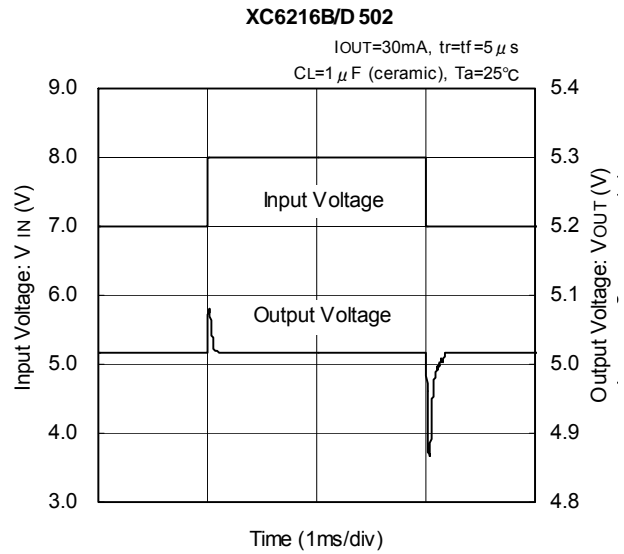
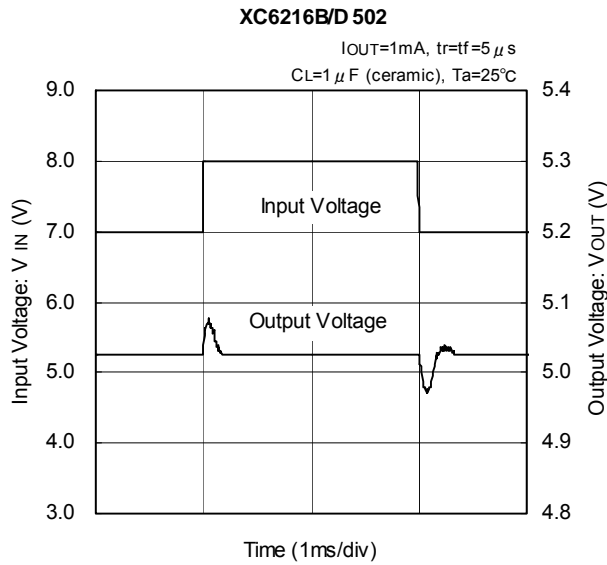

(7) Load Transient Response

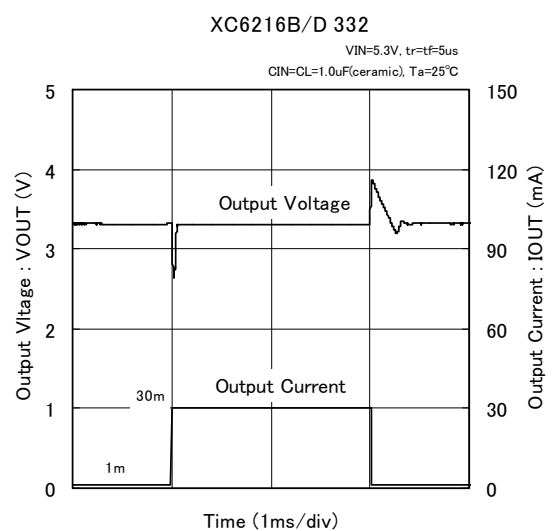
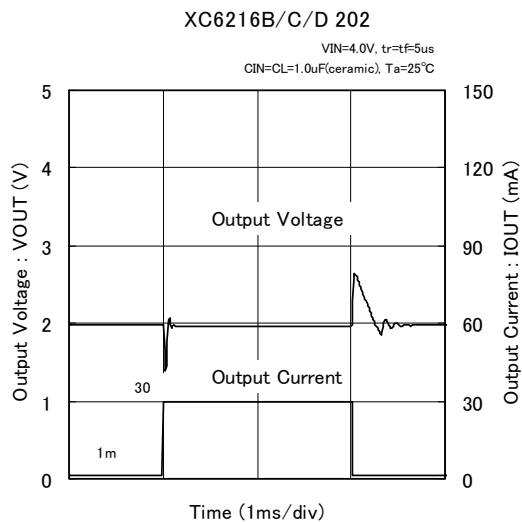

TYPICAL PERFORMANCE CHARACTERISTICS (Continued)

(7) Load Transient Response (Continued)

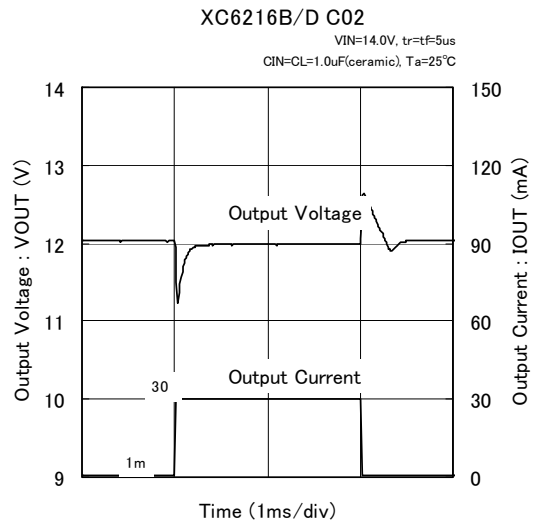
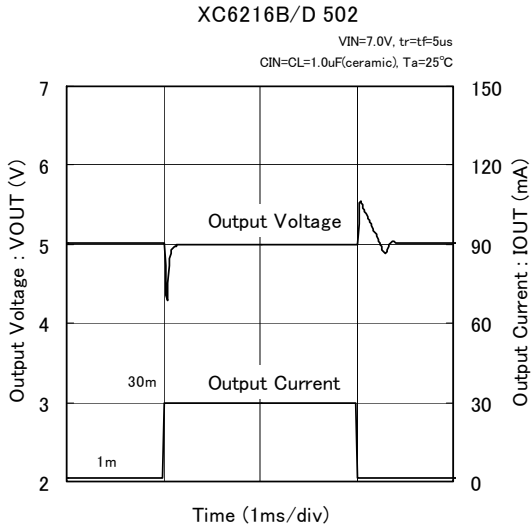

(8) Input Rise Time

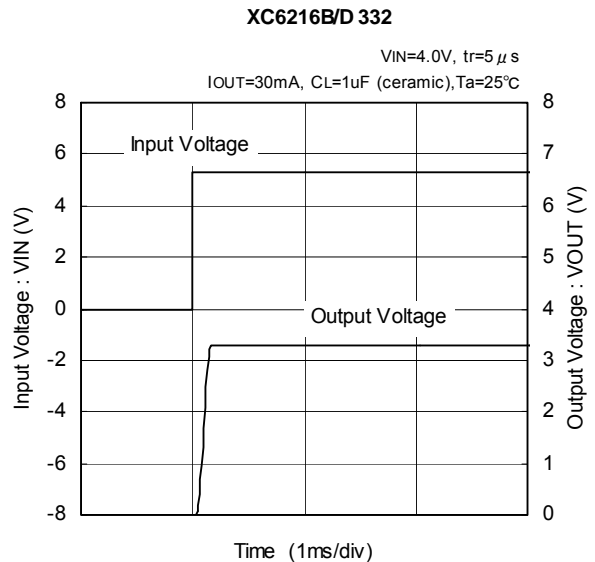
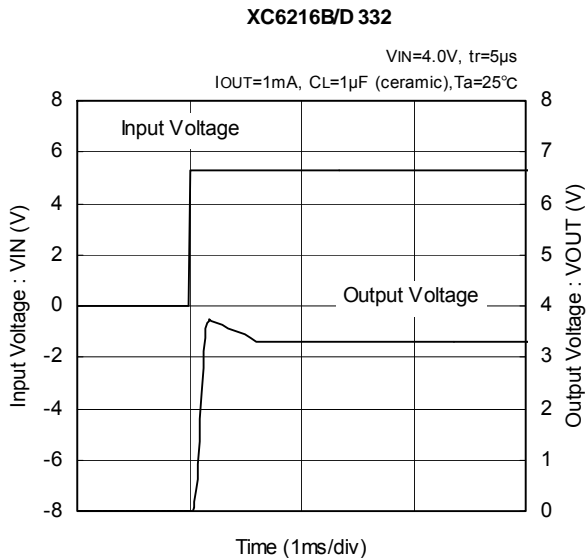
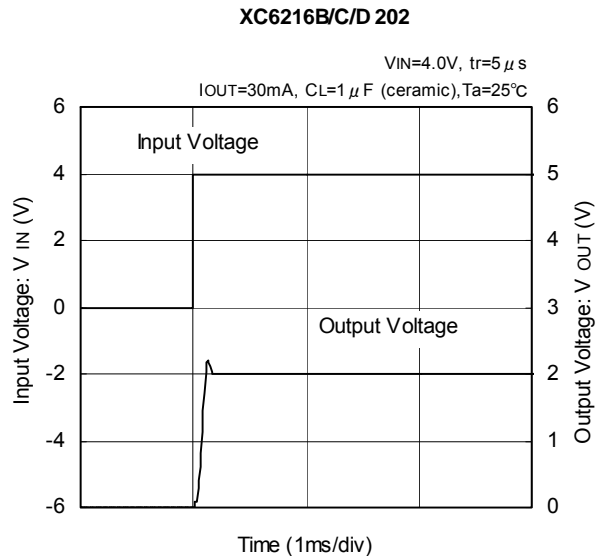
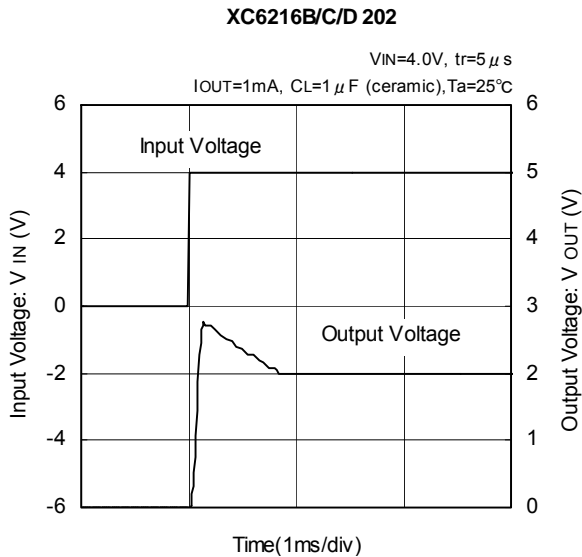

TYPICAL PERFORMANCE CHARACTERISTICS (Continued)

(8) Input Rise Time (Continued)

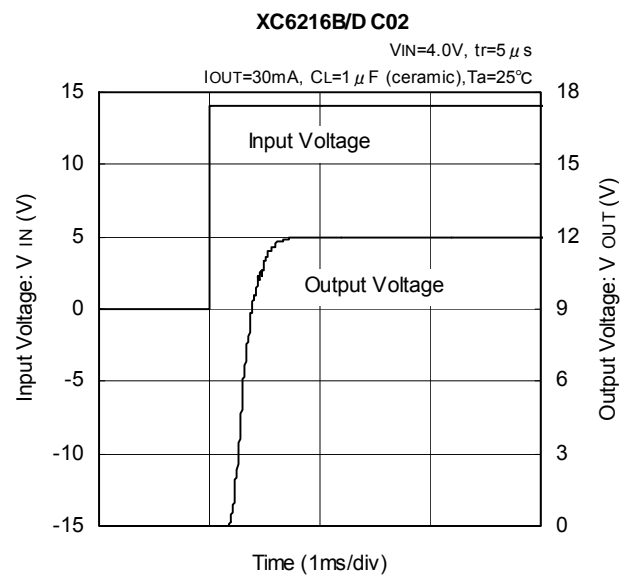
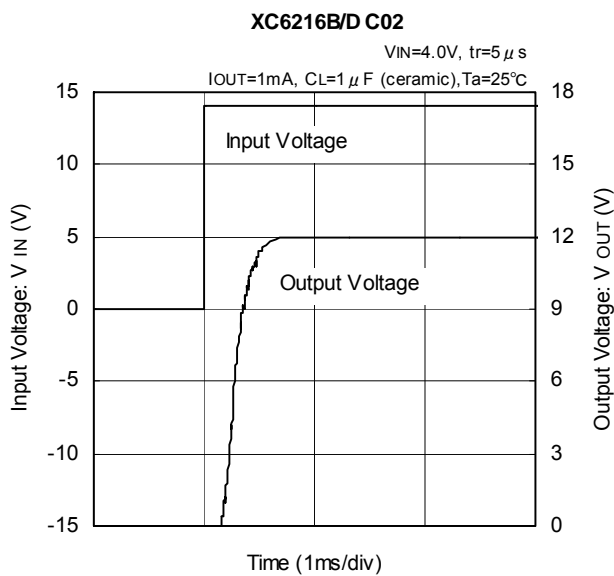
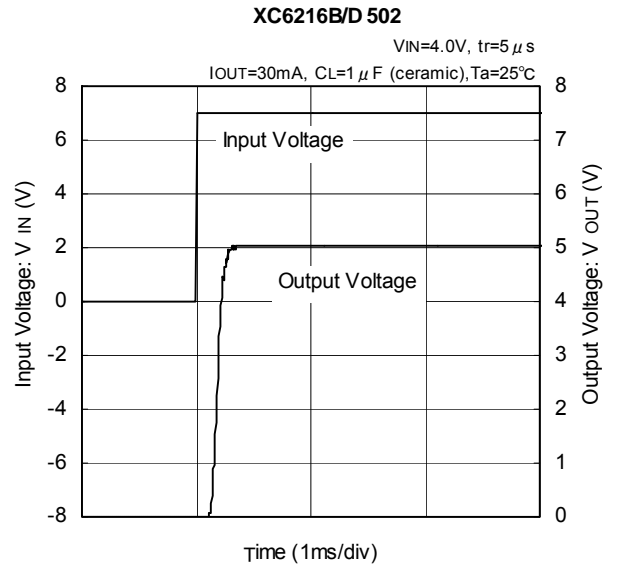
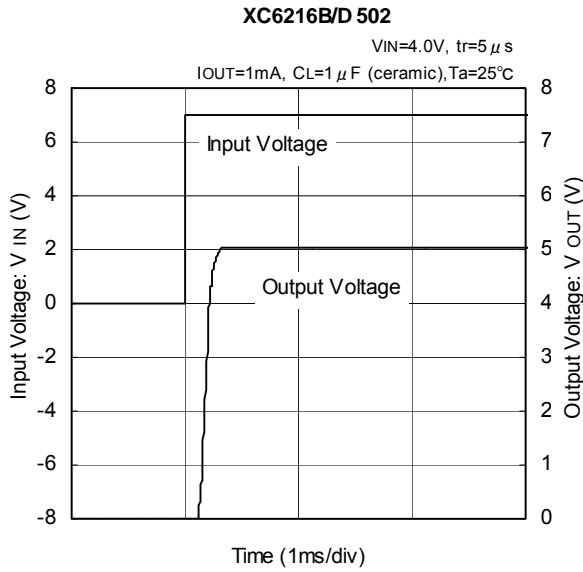

(9) CE Rise Time

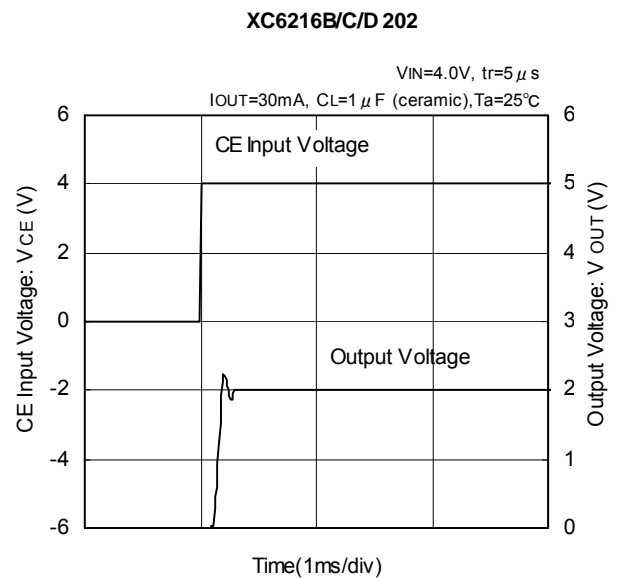
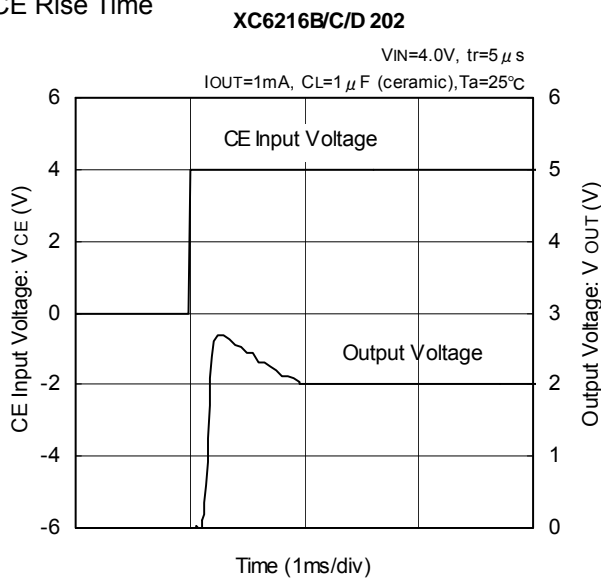

TYPICAL PERFORMANCE CHARACTERISTICS (Continued)

(9) CE Rise Time (Continued)

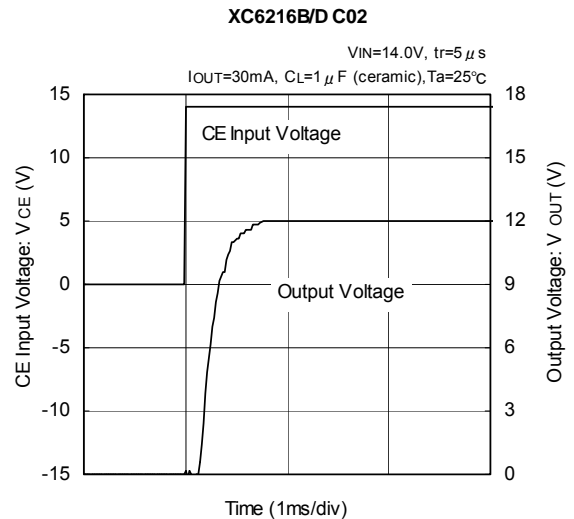
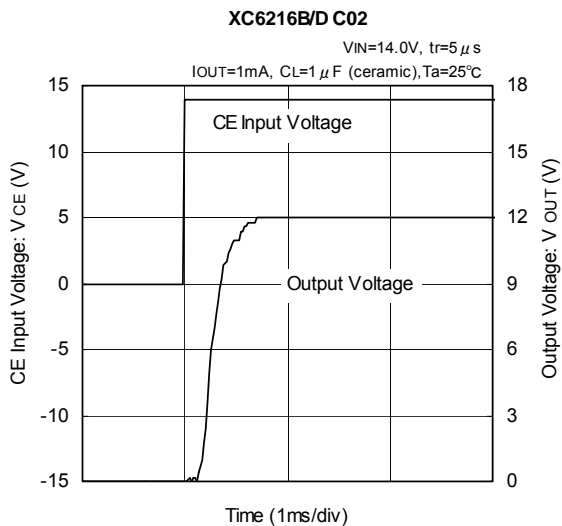
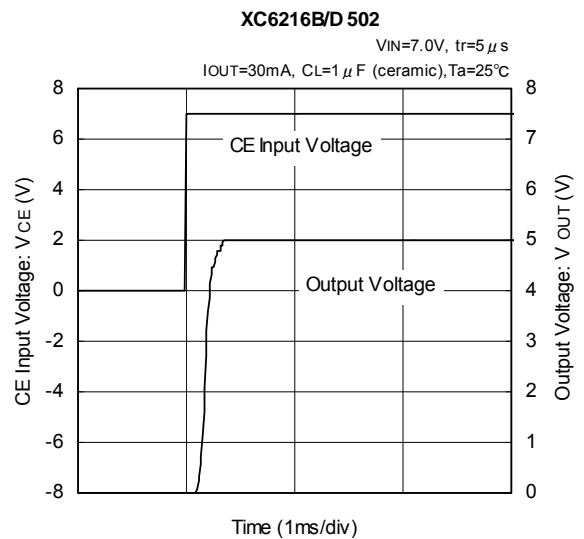
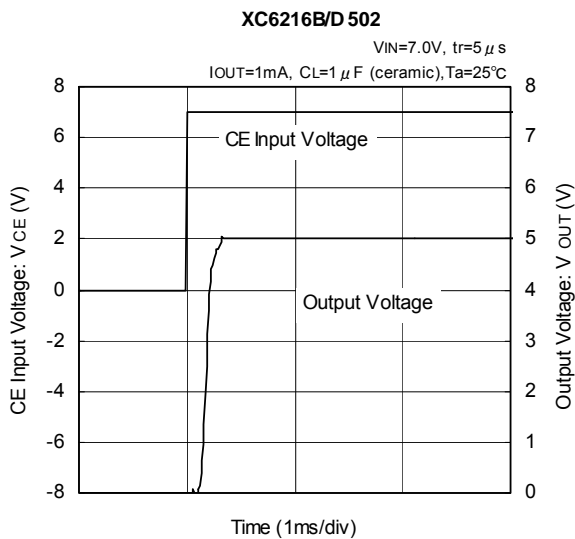
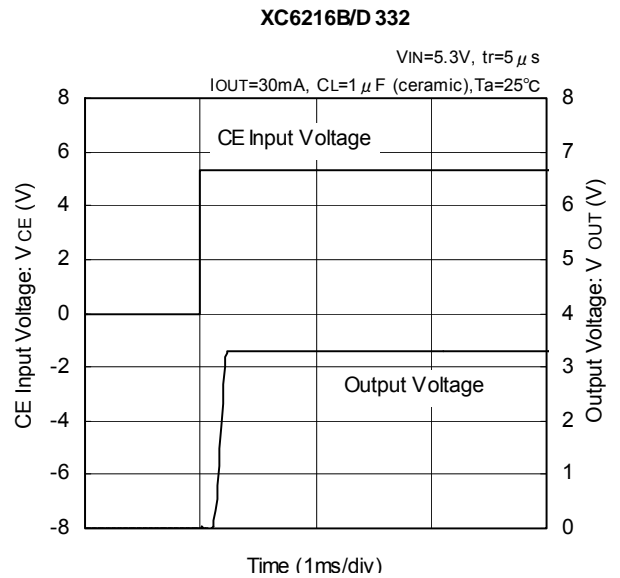
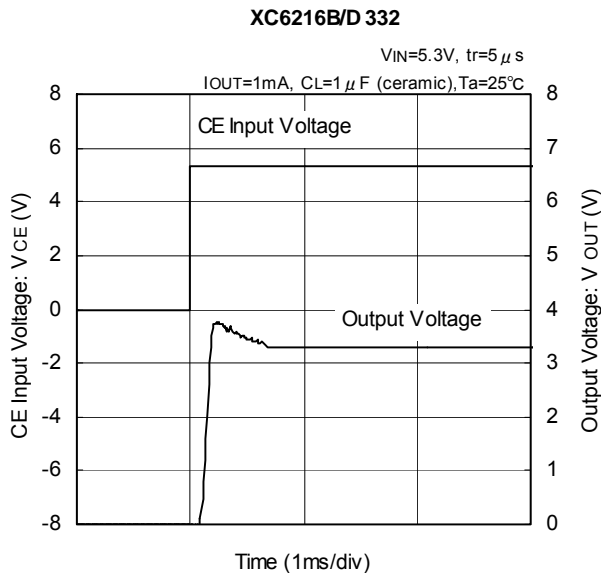

TYPICAL PERFORMANCE CHARACTERISTICS (Continued)

(10) Ripple Rejection Rate

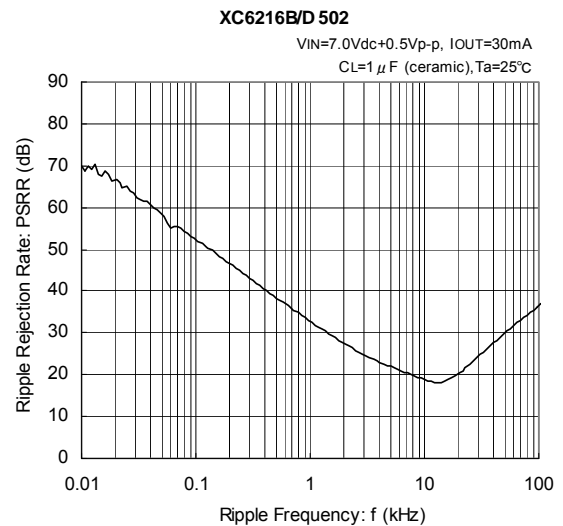
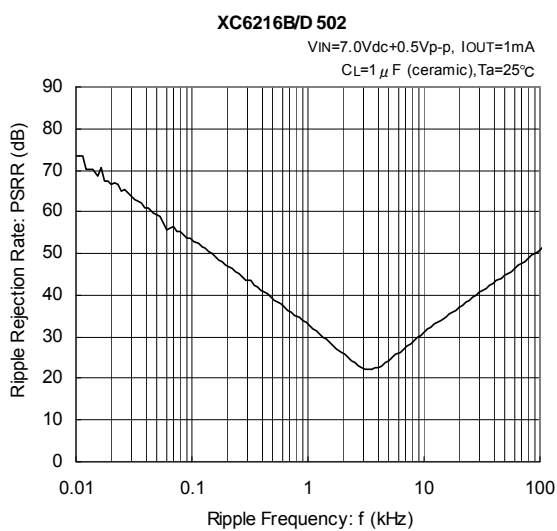
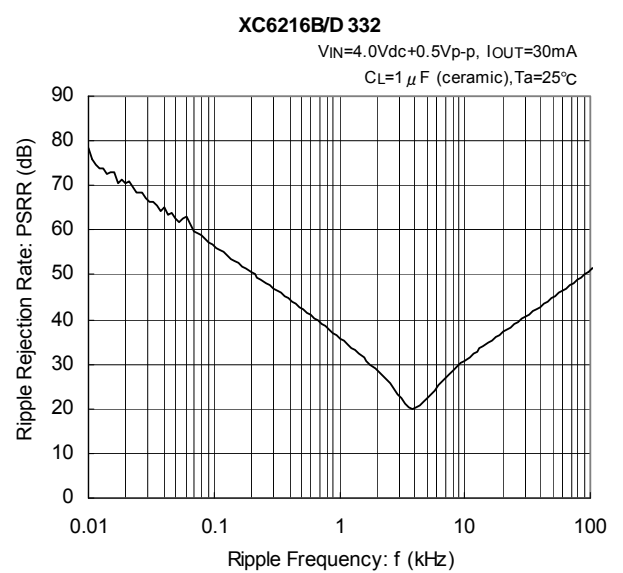
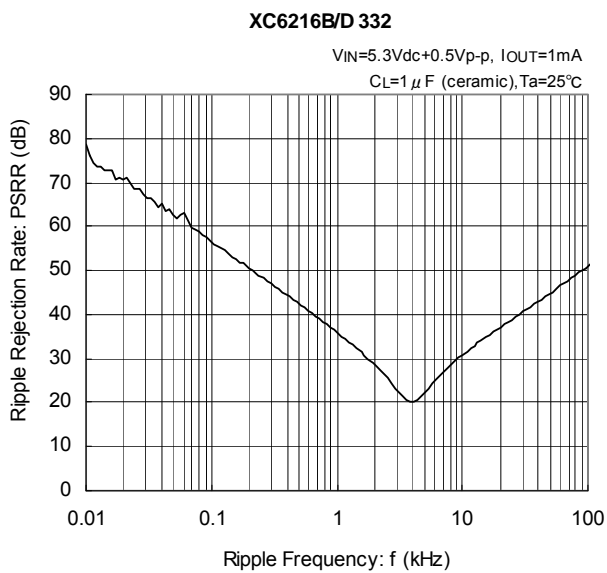
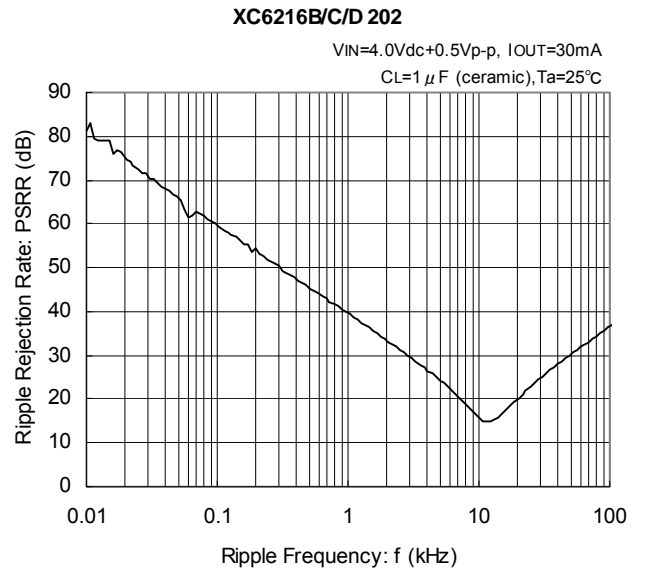
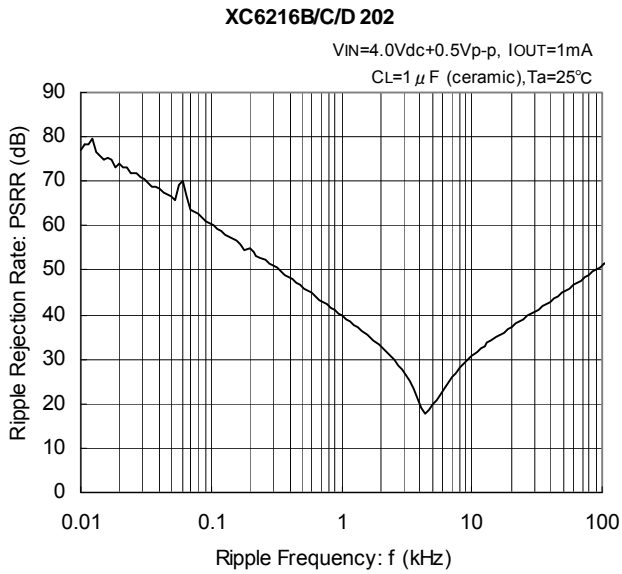

TYPICAL PERFORMANCE CHARACTERISTICS (Continued)

(10) Ripple Rejection Time (Continued)

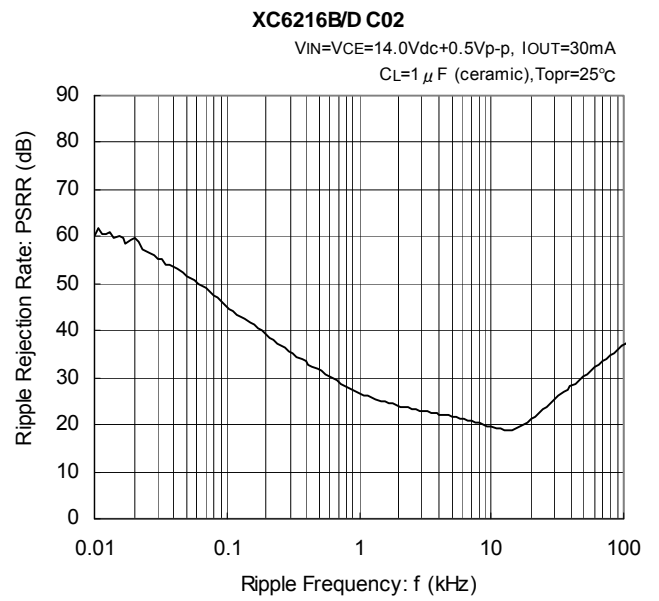
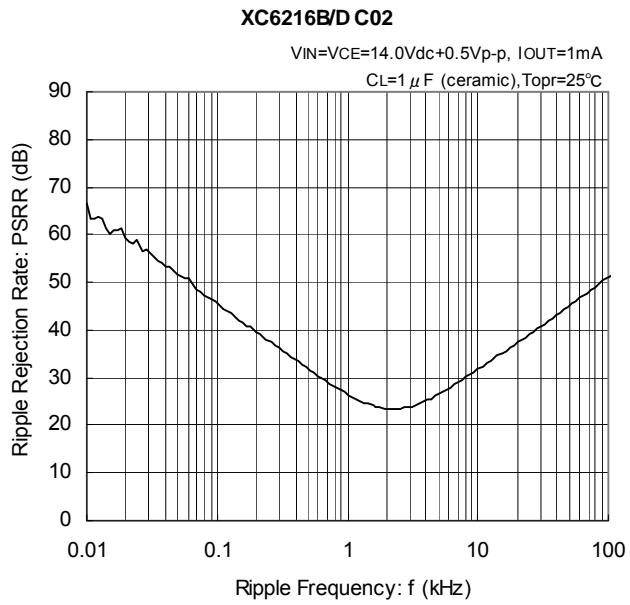

PACKAGING INFORMATION (Continued)

SOT-223

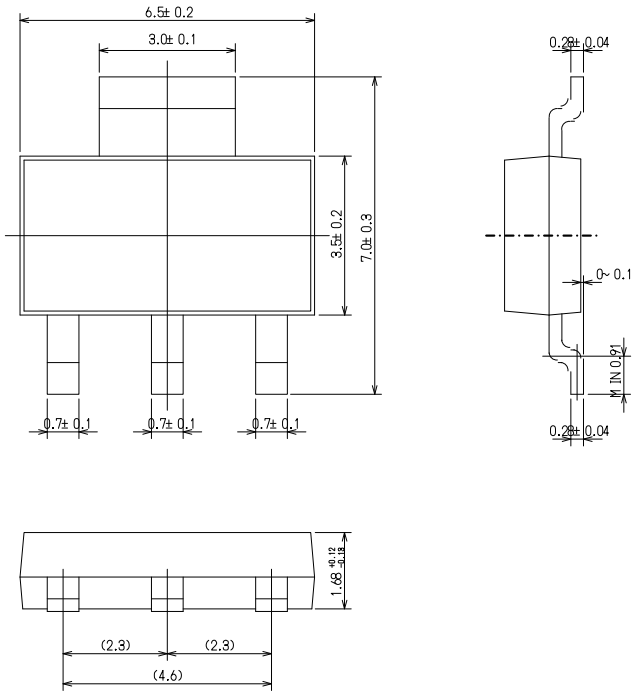

SOT-89

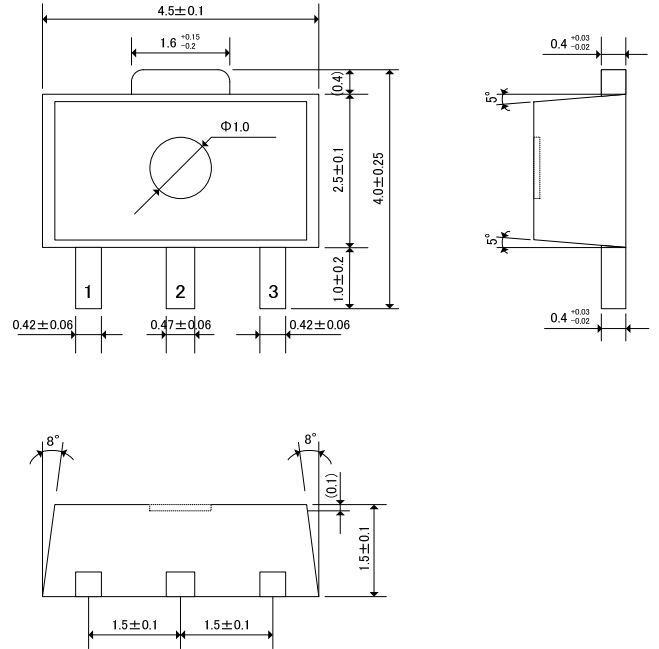

TO-252

(unit: mm)

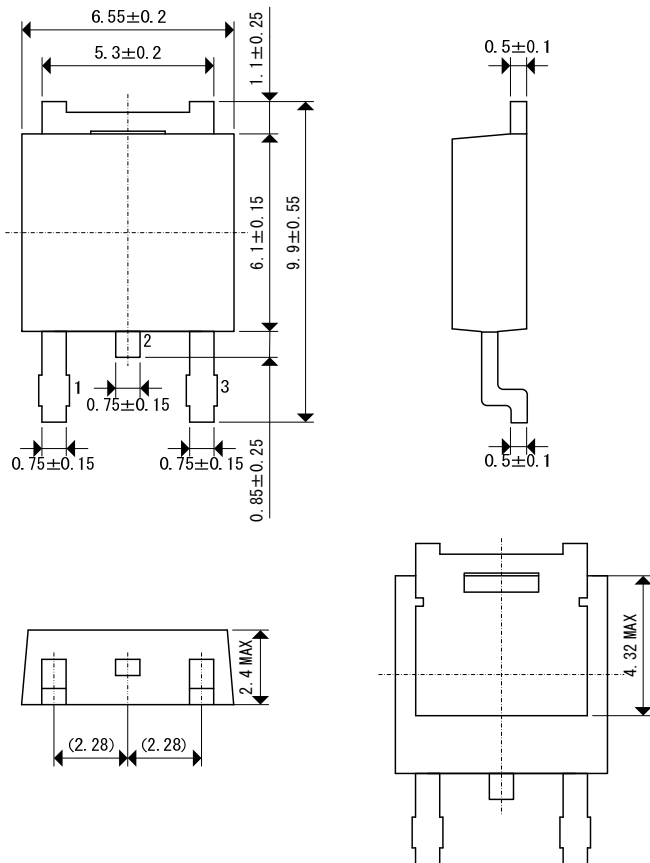

TO-252 Package

PACKAGING INFORMATION (Continued)

SOT-25 Power Dissipation

Power dissipation data for the SOT-25 is shown in this page.
The value of power dissipation varies with the mount board conditions.
Please use this data as one of reference data taken in the described condition.

1. Measurement Condition (Reference data)

- Condition: Mount on a board
Ambient: Natural convection
Soldering: Lead (Pb) free
Board: Dimensions 40 x 40 mm (1600 mm² in one side)
Copper (Cu) traces occupy 50% of the board area
In top and back faces
Package heat-sink is tied to the copper traces
(Board of SOT-26 is used.)
Material: Glass Epoxy (FR-4)
Thickness: 1.6 mm
Through-hole: 4 x 0.8 Diameter

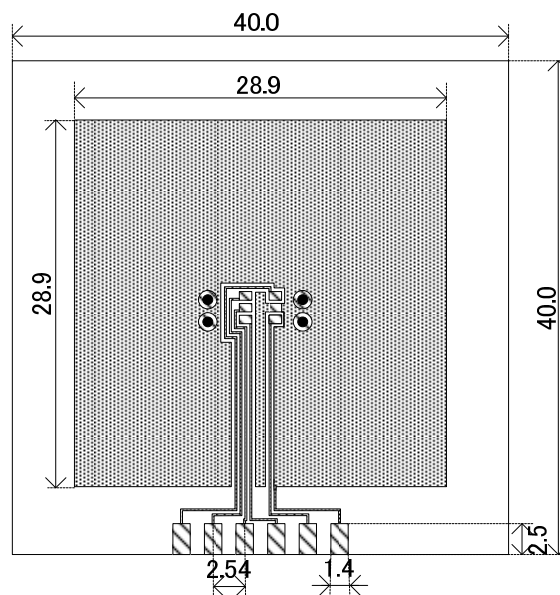

Evaluation Board (Unit: mm)

2. Power Dissipation vs. Operating temperature

Board Mount ($T_j \text{ max} = 125$)

Ambient Temperature (°C)	Power Dissipation Pd (mW)	Thermal Resistance (°C/W)
25	600	166.67
85	240	

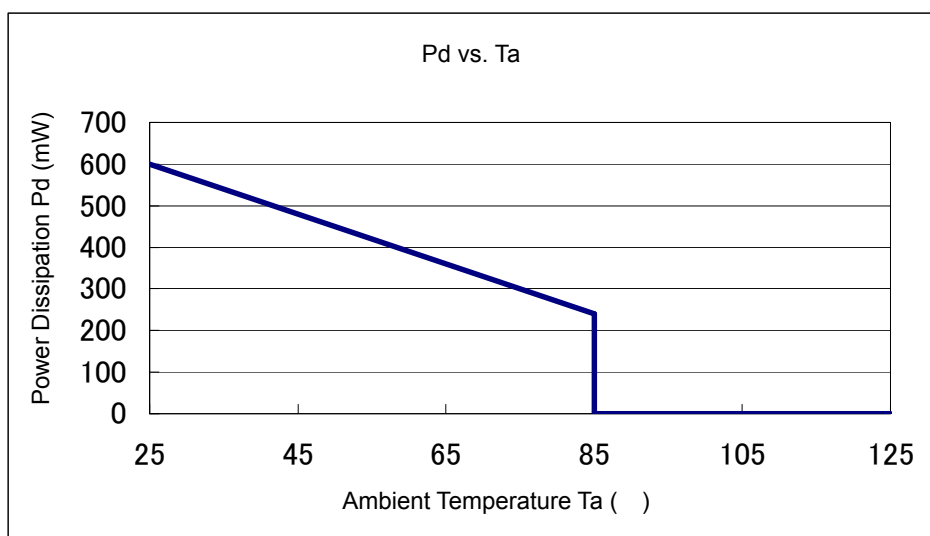

PACKAGING INFORMATION (Continued)

SOT-89-5 Power Dissipation

Power dissipation data for the SOT-89-5 is shown in this page.
 The value of power dissipation varies with the mount board conditions.
 Please use this data as one of reference data taken in the described condition.

1. Measurement Condition (Reference data)

- Condition: Mount on a board
- Ambient: Natural convection
- Soldering: Lead (Pb) free
- Board: Dimensions 40 x 40 mm (1600 mm² in one side)
 Copper (Cu) traces occupy 50% of the board area
 In top and back faces
 Package heat-sink is tied to the copper traces
- Material: Glass Epoxy (FR-4)
- Thickness: 1.6 mm
- Through-hole: 5 x 0.8 Diameter

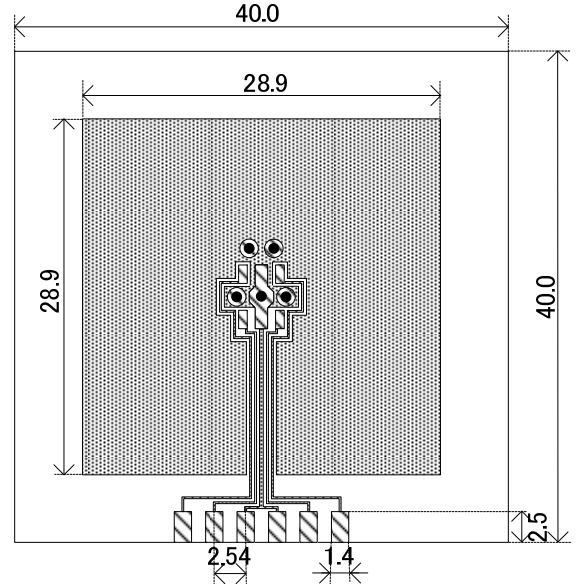

Evaluation Board (Unit: mm)

2. Power Dissipation vs. Operating temperature

Board Mount ($T_j \text{ max} = 125$)

Ambient Temperature (°C)	Power Dissipation Pd (mW)	Thermal Resistance (°C/W)
25	1300	76.92
85	520	

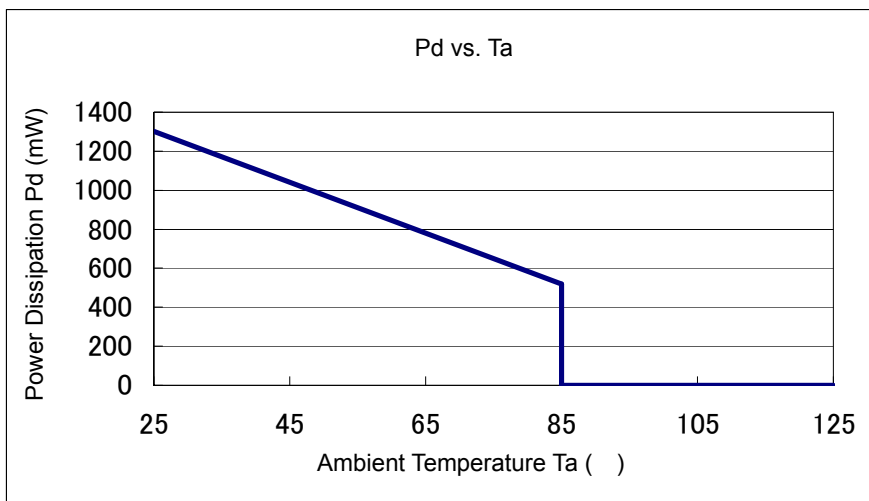

PACKAGING INFORMATION (Continued)

USP-6C Power Dissipation

Power dissipation data for the USP-6C is shown in this page.
The value of power dissipation varies with the mount board conditions.
Please use this data as one of reference data taken in the described condition.

1. Measurement Condition (Reference data)

- Condition: Mount on a board
- Ambient: Natural convection
- Soldering: Lead (Pb) free
- Board: Dimensions 40 x 40 mm (1600 mm² in one side)
Copper (Cu) traces occupy 50% of the board area
In top and back faces
Package heat-sink is tied to the copper traces
- Material: Glass Epoxy (FR-4)
- Thickness: 1.6 mm
- Through-hole: 4 x 0.8 Diameter

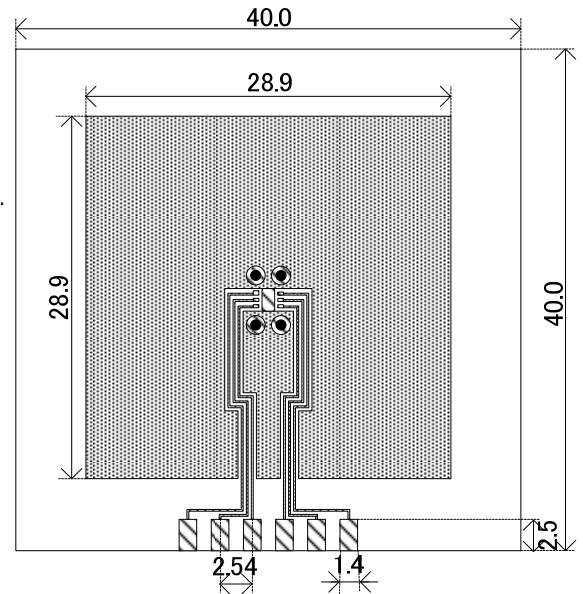

Evaluation Board (Unit: mm)

2. Power Dissipation vs. Operating temperature

Board Mount ($T_j \text{ max} = 125$)

Ambient Temperature(°C)	Power Dissipation Pd(mW)	Thermal Resistance (°C/W)
25	1000	100.00
85	400	

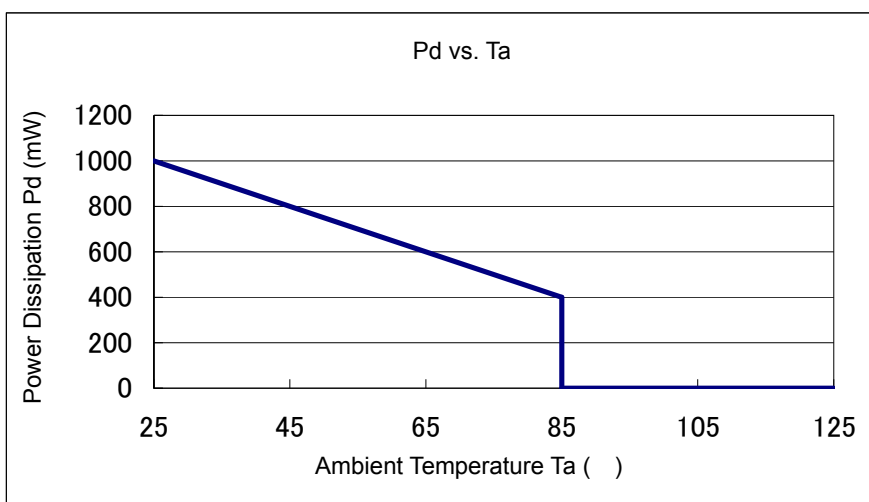

PACKAGING INFORMATION (Continued)

SOT-223 Power Dissipation

Power dissipation data for the SOT-223 is shown in this page.
 The value of power dissipation varies with the mount board conditions.
 Please use this data as one of reference data taken in the described condition.

1. Measurement Condition (Reference data)

- Condition: Mount on a board
- Ambient: Natural convection
- Soldering: Lead (Pb) free
- Board: Dimensions 40 x 40 mm (1600 mm² in one side)
 Copper (Cu) traces occupy 50% of the board area
 In top and back faces
 Package heat-sink is tied to the copper traces
- Material: Glass Epoxy (FR-4)
- Thickness: 1.6 mm
- Through-hole: 4 x 0.8 Diameter

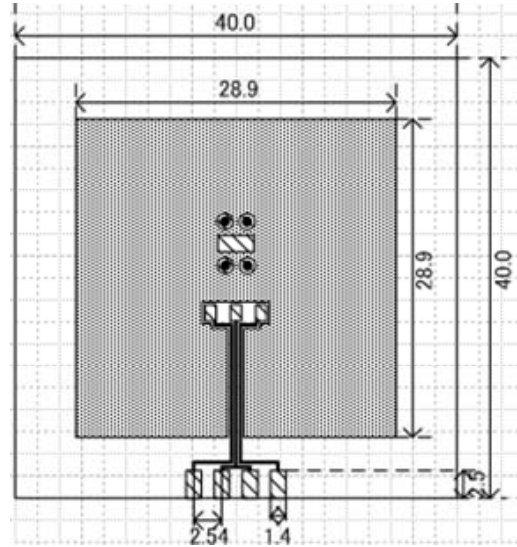

Evaluation Board (Unit: mm)

2. Power Dissipation vs. Operating temperature

Board Mount ($T_j \text{ max} = 125$)

Ambient Temperature (°C)	Power Dissipation Pd (mW)	Thermal Resistance (°C/W)
25	1500	66.67
85	600	

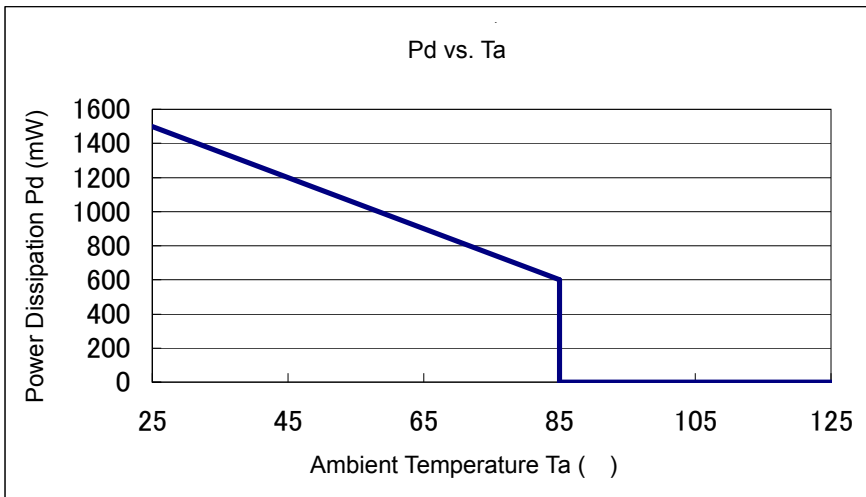

1. The products and product specifications contained herein are subject to change without notice to improve performance characteristics. Consult us, or our representatives before use, to confirm that the information in this datasheet is up to date.
2. We assume no responsibility for any infringement of patents, patent rights, or other rights arising from the use of any information and circuitry in this datasheet.
3. Please ensure suitable shipping controls (including fail-safe designs and aging protection) are in force for equipment employing products listed in this datasheet.
4. The products in this datasheet are not developed, designed, or approved for use with such equipment whose failure or malfunction can be reasonably expected to directly endanger the life of, or cause significant injury to, the user.
(e.g. Atomic energy; aerospace; transport; combustion and associated safety equipment thereof.)
5. Please use the products listed in this datasheet within the specified ranges.
Should you wish to use the products under conditions exceeding the specifications, please consult us or our representatives.
6. We assume no responsibility for damage or loss due to abnormal use.
7. All rights reserved. No part of this datasheet may be copied or reproduced without the prior permission of TOREX SEMICONDUCTOR LTD.

TOREX SEMICONDUCTOR LTD.